

Phase Three Modular Programmable Three Stage Smart Charger

Installation & Operation Manual Model: PTMP-24-100



Table of Contents

<u>Section/Topic</u>	<u>Page</u>
O) Quick Start/Product Overview	O
Section I) General Information/Product Features	I-1
Section II) Safety Instructions	II-1
Section III) Installation	III-1
▪ Opening Front Panel	
▪ Removal of Protective Packing Materials	
▪ Drip Shield Assembly	
▪ Mounting Location	
▪ AC Input Wiring	
▪ DC Output Wiring	
Section IV) System Status Display Overview	IV-1
▪ System Status Screen	
▪ Alarm Notification Screens	
▪ Indicator light	
Section V) Initial Startup/Default Settings/Calibrations	V-1
▪ Charger On-Off Control	
▪ View/Change Program Screen	
▪ Temperature Scale Set	
▪ Number of Battery Banks Monitored	
▪ Display Battery Sensor Temperature	
▪ Max Charge Amps	
Section VI) Overview of Programming Options	VI-1
▪ Default Settings	
▪ Setting Choices/Ranges	
Section VII) Battery Type Charge Program Selection and Adjustments	VII-1
▪ Gel, Flooded 1, Flooded 2, AGM, TPPL	
Section VIII) Custom Programing	VIII-1
▪ Float Voltage	
▪ Absorption Voltage	
▪ Max Charge Amps	
▪ Max Time Absorption Phase	
▪ Absorption End Amps	
▪ End of Absorption Condition (Amps/Time /Both)	
▪ Bulk Time Out	
▪ Equalization (Volts/Hours)	

Section IX) Alarm Conditions.....	IX-1
<ul style="list-style-type: none"> ▪ AC Input Failure ▪ Charger Over Temp ▪ Battery Over Temp ▪ High Charger Output Voltage ▪ Low Charger Voltage ▪ Internal Power Module Over Temp ▪ Power Module Failure ▪ Output Fuse Failure ▪ Controller Communication Failure 	
Section X) Optional Configurations/Accessories.....	X-1
<ul style="list-style-type: none"> ▪ Battery Temperature Compensation Sensors ▪ Alarm Contacts ▪ Remote Display Panel 	
Section XI) Maintenance/Component Replacement.....	XI-1
<ul style="list-style-type: none"> ▪ Fan ▪ Power Module ▪ Control Board ▪ Output Fuse ▪ Air Filter 	
Section XII) Three Stage Charging Theory and Settings.....	XII-1
<ul style="list-style-type: none"> ▪ Bulk, Absorption, Float, Equalize 	
Section XIII) Trouble Shooting.....	XIII-1
Section XIV) Specifications/Outline Drawings.....	XIV-1

Product Overview - Quick Start Guide

Drip Shield Installation,
Section III

System Status Screens,
Section IV

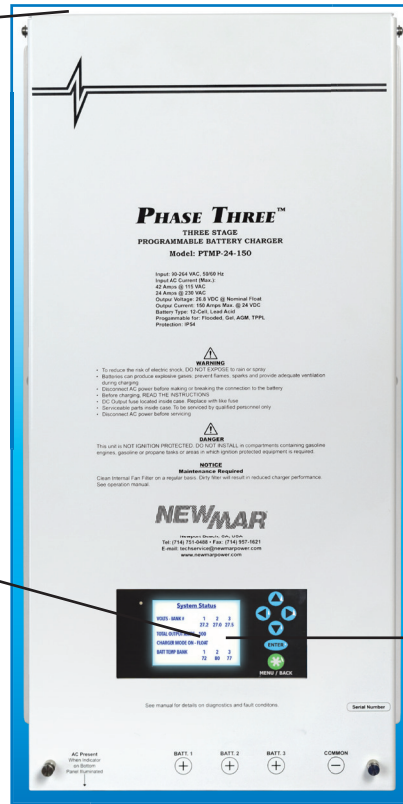

Programmable by Touch Pad

Standard Settings

- Battery Type, Section VII
- ON-OFF Control, Section V
- Temp Sensor Enable, Section X
- Number of Battery Banks Monitored, Section V
- Temp Scale, Section V

Custom Settings

- Float
- Absorption
- Max Time in Bulk Stage
- Absorption Time Out
- Max. Time in Absorption Stage
- Absorption Stage
- End Amps
- Absorption End Stage
- Condition
- Equalize Volts & Time

Air Filter Maintenance
Section XI

Power Module Replacement,
Section XI

Output Fuse Replacement
(Under Display, Section XI)

Remote Installation of
Display Panel, Section X

AC Input, Section III

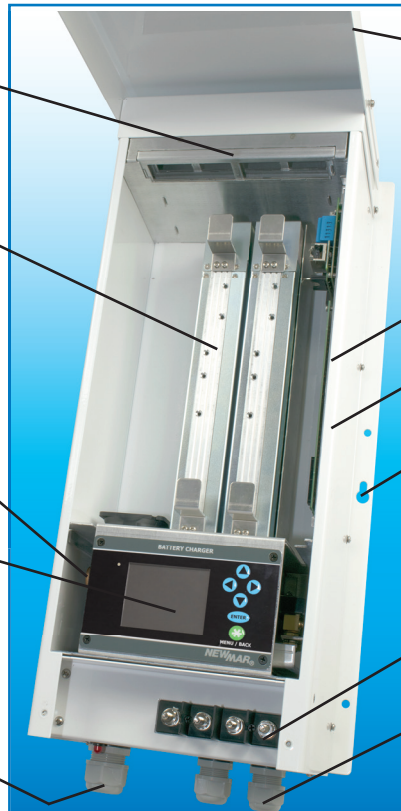

Opening Front Panel Access
Section III

Alarm Contacts, Section X

Battery Temp Sensor, Section X

Mounting, Section III;
Dimensional Drawings,
Section XIV

DC Output, Section III

Alarm Contacts and Temp
Sensor Wiring Port, Section X

SECTION I) General Information

The PTMP represents a new level of functionality, reliability, and serviceability in very smart battery charging for critical 24 volt systems aboard work boats, military, commercial, and recreational craft. A menu of pre-programmed battery type charge profiles as well as custom settings option allow user to select or program optimal three step charging voltages and operating parameters. The chargers interact with batteries providing the ideal profile for replenishment and conditioning, resulting in maximum performance and extending service life.

Features

- User selection of Pre-programmed charge profiles for multiple battery types. Gel/Lead Acid/AGM/TPPL
- On-screen status and system diagnostics, with audio alarm
- Independent temperature sensors, 3 battery banks (optional)
- 3 step charging for long battery life
- Equalization program
- Remote Status monitoring via Form C relay contacts
- Multiple modules provide redundancy and qualifies as redundant ABS essential service device
- Easy front panel access to plug-in modules for quick field service, no need to remove charger from vessel, high tech personnel not required
- IP45 water and material ingress protection



- Multiple output banks charge independently based on demand
- "Universal" input of 90 - 264V AC, 50 - 60 Hz input with no setting of selector switch required - can be used anywhere in the world
- Current limiting prevents damage from overload
- Cooling fan allows continuous operation at full-rated output
- High charge voltage time-out circuit prevents overcharge during continuous high amperage demand

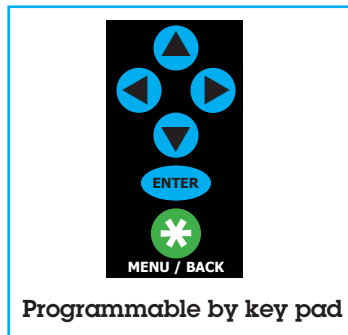

Programmable by key pad

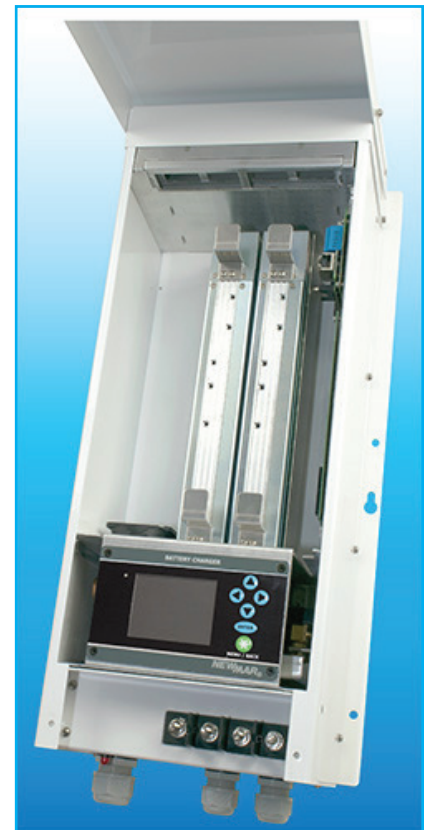

Easy Front Panel Access to Plug & Play Components

Options

- Remote installation of LCD display and touch pad.
- Battery Temperature Sensors.
- Remote Alarm Contacts



Battery Temp. Sensor

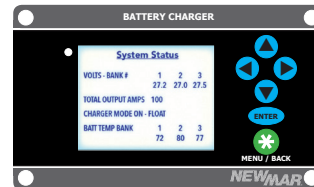

Remote Panel

In addition, your PTMP Charger carries a full two year warranty against defects in materials or workmanship from the date of purchase. Careful attention to these instructions should help you enjoy years of trouble-free service.

SECTION II) Important Safety Instructions

1. **SAVE THESE INSTRUCTIONS** – This manual contains important safety and operating instructions for the Phase Three Modular Programmable Battery Charger.
2. Before using this battery charger, read all instructions and cautionary markings on (1) the battery charger, (2) the battery, and (3) product powered by the battery.
3. **CAUTION** – To reduce the risk of injury, charge only 6 cell or 12 cell gel-cell or lead-acid rechargeable batteries. Other types of batteries may burst, causing personal injury and damage.
4. Do not expose charger to rain or spray.
5. Use of an attachment not recommended or sold by NEWMAR may result in a risk of fire, electric shock or injury to persons.
6. To reduce the risk of damage to the electric plug and cord (if plugged into an AC outlet), pull by plug rather than cord when disconnecting the charger.
7. Make sure the cord is located so that it will not be stepped on, tripped over, or otherwise subjected to damage or stress.
8. An extension cord should not be used unless absolutely necessary. Use of an improper cord could result in the risk of fire and electric shock.
9. Do not operate the charger with a damaged cord or plug; replace them immediately.
10. Do not operate the charger if it has received a sharp blow, been dropped, or otherwise damaged; take to a qualified serviceman.
11. To reduce the risk of electric shock, disconnect the charger from AC source before attempting any maintenance or cleaning.

WARNING – RISK OF EXPLOSIVE GASES

1. WORKING IN THE VICINITY OF A LEAD-ACID BATTERY IS DANGEROUS. BATTERIES GENERATE EXPLOSIVE GASES DURING NORMAL BATTERY OPERATION. FOR THIS REASON, IT IS OF THE UTMOST IMPORTANCE THAT BEFORE INSTALLING AND USING YOUR CHARGER, YOU READ THIS MANUAL AND FOLLOW THE INSTRUCTIONS EXACTLY.
2. To reduce the risk of battery explosion, follow these instructions and those published by the battery manufacturer and by the manufacturer of any equipment you intend to use in the vicinity of the battery. Review cautionary markings on these products.

PERSONAL PRECAUTIONS

1. Someone should be within range of your voice or close enough to come to your aid when you work near a lead-acid battery.
2. Have plenty of fresh water and soap nearby in case battery acid contacts skin, clothing, or eyes.
3. Wear complete eye and clothing protection. Avoid touching your eyes while working near a battery.
4. If battery acid contacts skin or clothing, wash immediately with soap and water. If battery acid enters the eye, immediately flood eye with running cold water for at least 10 minutes and get medical attention immediately.
5. NEVER smoke or allow a spark or flame in the vicinity of the battery or engine.
6. Be extra cautious to reduce the risk of dropping a metal tool onto the battery. It might spark or short-circuit the battery or other electrical part and cause an explosion.
7. Remove personal metal items such as rings, bracelets, necklaces, and watches when working with a lead-acid battery. A lead-acid battery can produce a short-circuit high enough to weld a ring or the like metal, causing a severe burn.

8. Use the battery charger for charging gel-cell or flooded lead-acid batteries only. It is not intended to supply power to a low voltage electrical system other than in a starter-motor application. Do not use the charger for charging dry-cell batteries that are commonly used with home applications. These batteries may burst and cause injury to persons and damage to property.
9. NEVER charge a frozen battery.

PREPARING TO CHARGE

1. Be sure the area around the battery is well ventilated.
2. Clean battery terminals. Be careful to keep corrosion from coming in contact with eyes.
3. Add distilled water in each cell until battery acid reaches level specified by battery manufacturer. This helps purge excessive gas from cells. Do not overfill. For a battery without cell caps, carefully follow manufacturer's recharging instructions.
4. Study all battery manufacturers' specific precautions charging and recommended rates of charge.

GROUND AND AC POWER CORD CONNECTION

1. The charger should be grounded to reduce risk of electrical shock.

(For Marine Applications only) EXTERNAL CONNECTIONS TO THE CHARGER SHALL COMPLY WITH UL RECOMMENDATIONS AND/OR UNITED STATES COAST GUARD ELECTRICAL REGULATIONS (33CFR183, WSUB-PART D)

(For Marine Applications only) THE INSTALLATION AND PROTECTION OF VESSEL WIRING ASSOCIATED WITH BATTERY CHARGERS SHALL COMPLY WITH ABYC STANDARDS E-11) AC & DC ELECTRICAL SYSTEMS ON BOATS, AND A-31) BATTERY CHARGERS & INVERTERS

SECTION III) Installation

Important Pre-installation notes:

1) Protective foam packing material for protection during shipment is placed inside the charger, as well as, externally under the air baffle plate at the bottom which must be removed before installation, see **Figures 3.3 and 3.4**.

Remove Internal Foam Material: Release the latches on the side of the charger and raise the front panel, see **Figures 3.1, 3.2 and 3.3**

Figure 3.1, 3.2, & 3.3

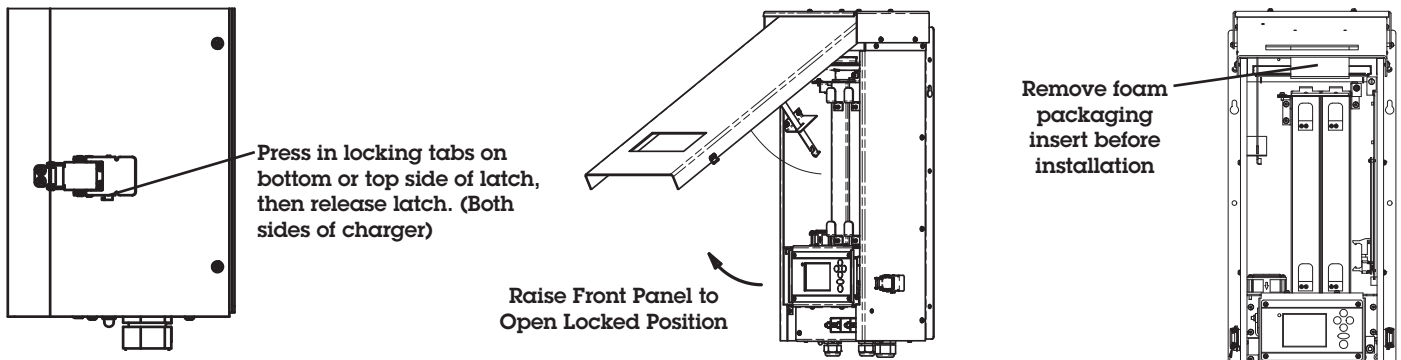

A foam insert piece near the top end of the unit must be removed.

Remove External Foam Material: At the bottom of the mounting plate remove the foam insert in the air baffle area.

Figure 3.4

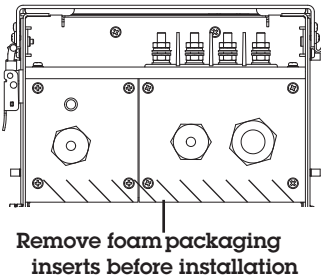

2) Install drip shield: see **Figure 3.5** by securing 4 top screws and 4 side screws

Figure 3.5

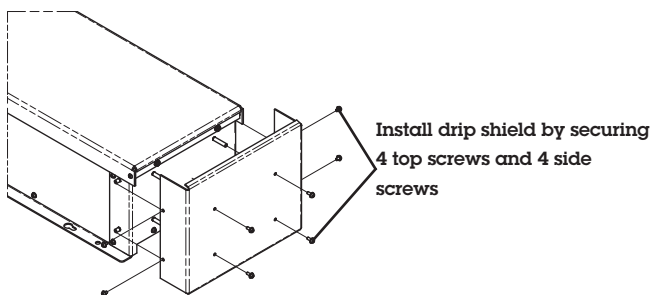

3) It is recommended that for ease of programming, you may first want to power up the unit on a test bench where the settings for your system can easily be made either by the touch panel. Programming can be done by applying either AC or connecting batteries, see **Section V** for details.

A) Materials Provided: Materials Provided Separate From Charger in Bag

- | | |
|--|--------------------------------|
| 1 ea. Installation Manual | 2 ea. Spare Filter |
| 1 ea. Output Terminal Protective Cover (clear plastic) | 1 ea. Small Newmar Screwdriver |
| 1 ea. Drip Shield and Installation Hardware | |
| 2 ea. Cord Grip (1 x 0.2"-0.5" & 1 x 0.35"-0.7") | |

The installer must provide four suitable 1/4" or 6mm mounting screws/washers, as well as, DC output wiring and 1/4" ring lug connectors and AC input wiring. Proper sizes and gauges for the wire and connectors are noted in **Section III**.

B) Location

The charger should be mounted on a bulkhead or other suitable mounting surface as close to the batteries to be charged as possible. Do not mount the charger directly over the batteries as fumes may cause excessive corrosion. **WARNING: The charger is not ignition protected, so it must not be located in an area where the ignition protected equipment is required.** The area should be well ventilated and free from excessive moisture, exhaust manifolds, and battery fumes.

Vertical mounting is preferred. However, horizontal mounting is acceptable where absolutely necessary. *Do not mount the charger where direct contact with water, spray or condensation can occur, as this will shorten charger life.* It should not be located where there is a possibility of debris being drawn into the unit through the fan. A minimum of 2" clearance around the charger is recommended for proper cooling.

If the charger is located in an extreme heat area, such as an unventilated engine room, and maximum operating temperature is exceeded, an automatic thermal shutdown protection circuit will turn the charger completely off. Thermal cycling will shorten the life of the charger, so if this condition occurs repeatedly, the charger should be relocated. For optimum performance and longer life, the charger should not be located in area of extreme high temperature.

C) Mounting

Depending on the type of mounting surface utilize either self-tapping or machine screws to secure the unit in place. There are 6 mounting holes plus two "Key holes" which can be utilized to hang the charger while the permanent mounting screws are being installed. See **page XIV-3** for dimensional drawing to determine mounting hole locations.

D) DC Output Wiring

Note: Only qualified service personnel should access the output terminals of the charger.

Whether working with existing battery charger output wires or installing new ones, make sure the battery(s) is disconnected from these wires before connecting them to the charger's output terminals

For a secure installation, DC output wires must be attached with 1/4" crimp lug terminals sized appropriately to fit wire gauges as listed in Table 1: DC Wire Size. Consult battery data sheet to determine battery terminal ring size.

The DC wire size table that follows may be used to determine the correct gauge wire and the length of the wire run from the charger to the batteries. Use a 7/16" nut driver or socket wrench to tighten output terminals. Once the output wiring has been attached to the chargers output posts, install the clear plastic terminal cover provided with the charger

Table 3.1: DC Wire Size

DC Wire Size Table			
Model	DC Wire Size Table		
	10'	15'	20'
Wire Gauge AWG (mm)			
PTMP-24-100	#2 (35mm)	#2 (35mm)	#2 (35mm)
* Based on ABYC 3% voltage drop table and NEC minimum wire size chart			

WARNING: ENSURE THAT LEADS ARE PROPERLY FUSED AT THE BATTERY. (REFER TO ABYC RECOMMENDATIONS.)

A note about the internal DC fuse: The internal wiring of the PTMP charger is protected against dangerous overheating in the event of an internal short or reverse polarity hook-up.

Figure 3.6: Simple D.C. Wiring (Preferred Method)

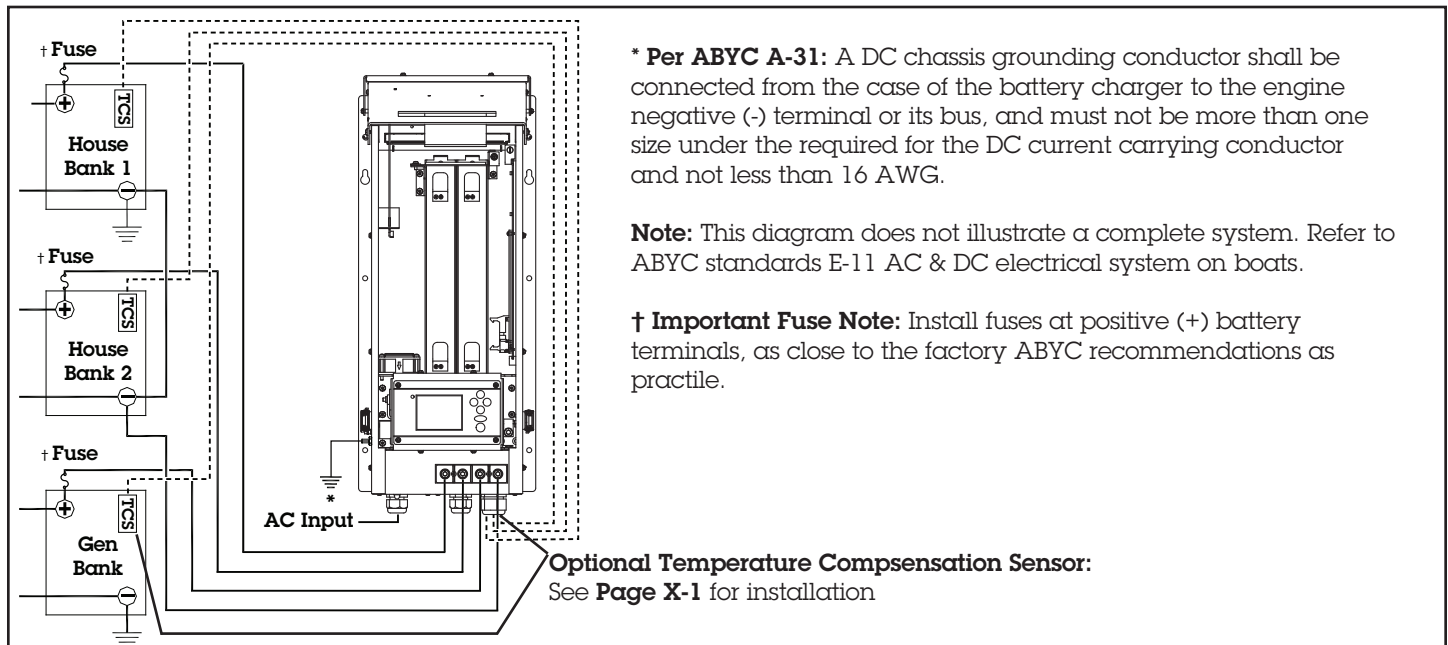

It is recommended that DC wiring from the charger to the batteries be as direct as possible. Line voltage loss and electronic noise interference of sensitive electronics are possible if the charging leads are routed through a central electrical distribution panel. Any elaborate configurations are best left to a qualified electrician.

ENSURE THAT LEADS ARE PROPERLY FUSED AT THE BATTERY. (REFER TO ABYC RECOMMENDATIONS. SEE REFERENCE APPENDIX AT THE END OF THIS MANUAL FOR ABYC CONTACT INFORMATION.)

Ensure that your connections are tight and that correct polarity is carefully observed at all times. The battery posts should be free of any rust or corrosion.

IMPORTANT NOTE: EVEN MOMENTARY REVERSE POLARITY CONNECTION MAY SEVERLY DAMAGE YOUR CHARGER. THE POSITIVE (+) TERMINAL MUST BE WIRED TO THE POSITIVE POST OF THE BATTERY AND THE NEGATIVE OR COMMON (-) TERMINAL TO THE NEGATIVE POST OF THE BATTERY OR COMMON BUS.

Figure 3.7: Wiring with Battery Switch

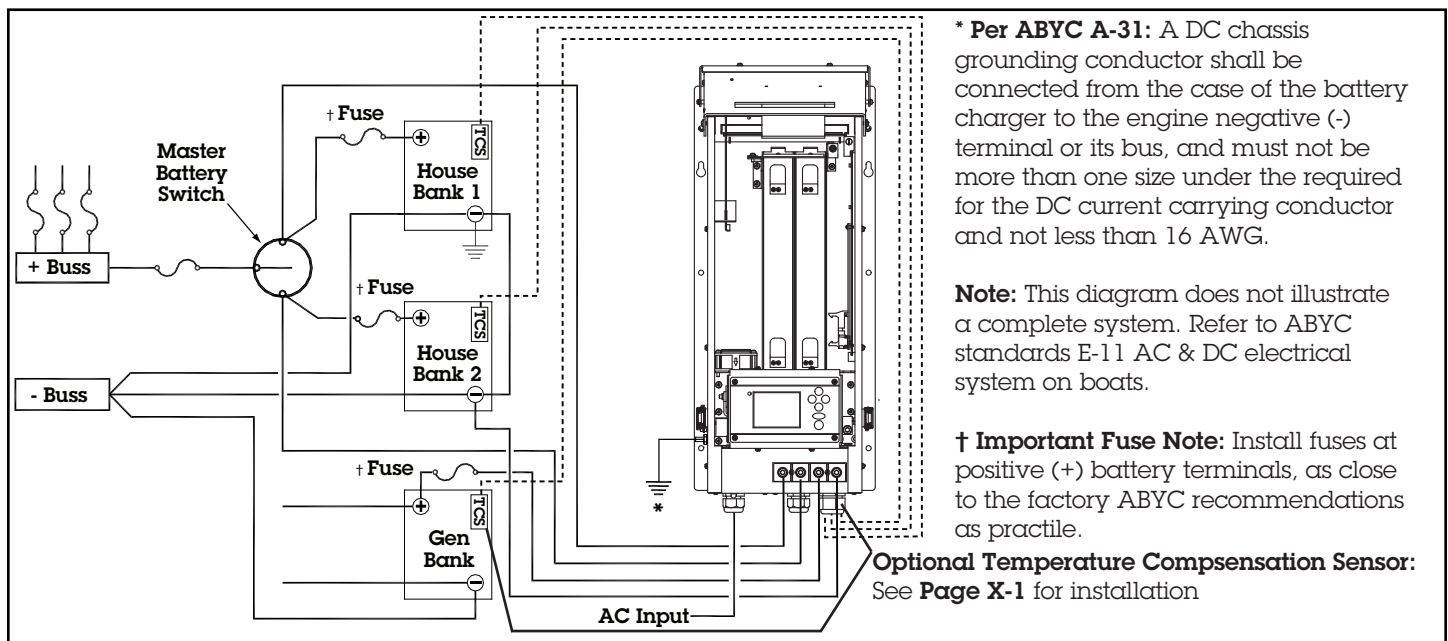

E) Multiple Unit Parallel Wiring

If increased power or system redundancy is required, a second charger may be wired in parallel. The unit is diode protected so it will not be damaged by feedback from the second unit and current limiting will prevent overloading in the case of a failure of one of the units.

Observe the following guidelines when wiring a parallel unit.

- 1) Use another identical charger model. Do not use a different charger model, either from NEWMAR or from another manufacturer.
- 2) Output wire length and gauge must be identical for each charger to ensure proper load sharing.
- 3) Wire gauge for each charger must be the same used as if a single charger were wired into the system itself. Wire each battery charger directly to the battery (**Figure 1**) or battery switch (**Figure 2**). **DO NOT daisy chain charger outputs.**

F) AC Input Wiring

AC input is "universal" and operates in a range of 90-264 VAC, 47-63 Hz., single phase. No switch setting is required for either 115V AC or 230V AC applications. *Caution (230V applications only): If AC input is derived from a source consisting of two HOT leads (phase-to-phase 230V AC input voltage) an external fuse or circuit breaker must be used to protect the unfused (formerly NEUTRAL, now HOT) lead.*

AC Input for the charger must be routed from a fuse or circuit breaker on an AC distribution panel with proper safety/earth chassis ground in accordance with all applicable local codes and ordinances

Input Current @ Full Load:

115 VAC = 30 Amps
230 VAC = 17 Amps

Recommended AC Input Wire Size:

115 VAC Input = 10 AWG minimum
230 VAC Input = 12 AWG minimum

Recommended AC Input Circuit Breakers:

115 VAC Input = 35 Amp
230 VAC Input = 20 Amp

AC wiring procedure, see **Figures 3.8 & 3.9**

The AC input access plate is located on the bottom panel of the charger, thus making the mains input wire connections is easier if done prior to mounting the charger to the bulkhead.

- 1) Remove the four plate mounting screws
- 2) Push the plate towards the back of the charger to clear the lip in the case above it.
- 3) Carefully pull the assembly out noting that there will be resistance caused by the internal wiring that is connected to the terminal block bracket attached to the rear of the plate.

Figure 3.8: Removing AC Input Access Plate

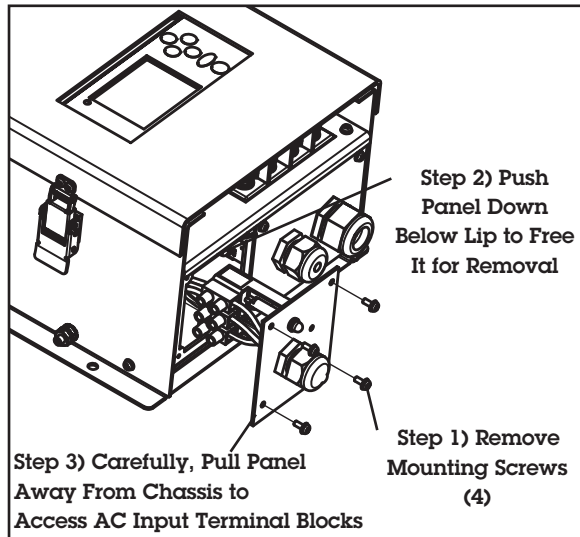
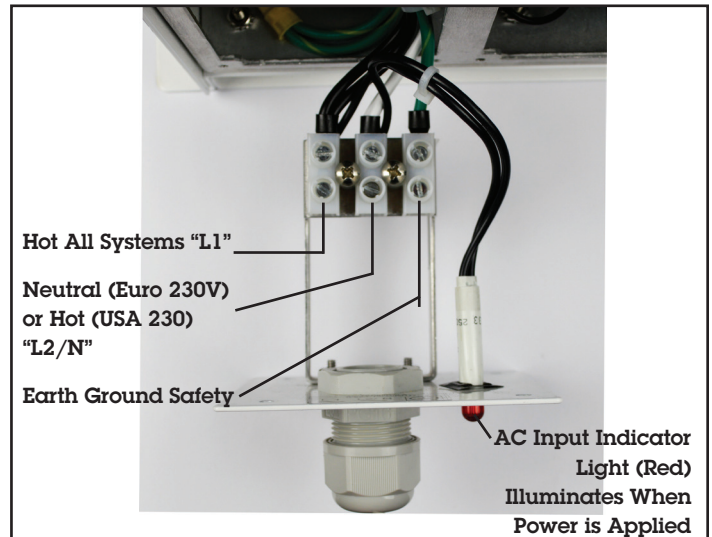

Figure 3.9: AC Input Connections



- 4) Install the strain relief/cord grip (provided) in the access plate and route the cable through it leaving approx. 4" of wire on the internal side. The strain relief accommodates cable diameter of .2" to .5".
- 5) Make mains connections to the terminal block per **Figure 3.9**
- 6) Push the terminal block/plate assembly back into place and secure the 4 mounting screws.
- 7) Note AC input cable external to charger should be secured/supported every 18" per ABYC E-11 code.

-----See Section V for Installation Start-Up Settings-----

SECTION IV: System Status Screen Function and Overview

The PTMP has a front panel status screen, indicator light/buzzer, and key pad, here is an overview of its functions and programming.

Note: to extend life of the text screen, sleep mode initiates after 30 seconds of in activity and the screen blanks out. Press any key pad position to activate.

Each time the unit is power by AC, an "Initialize" screen will first appear briefly before cycling through the "System Status" screen.

The default screen is "System Status" as shown below, under nominal conditions

Figure 4.1: Status Screen

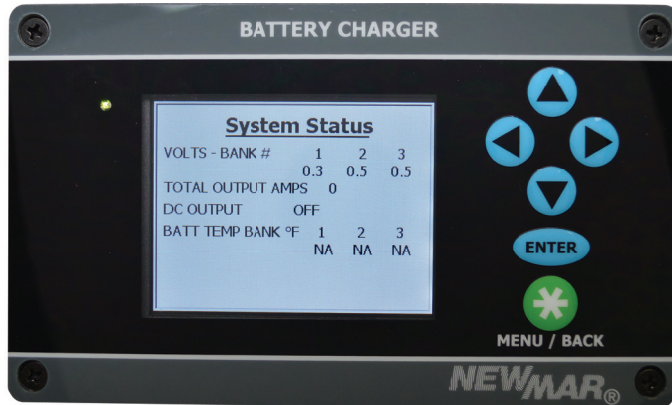

This screen contains 4 data lines:

- 1) Volts-Bank:** displays voltage output to each of 3 battery banks, note display of one battery bank display is default setting, to add display of second and third bank, program the display as described in **Section V**.
- 2) Total Output Amps:** displays combined total current supplied by charger to all banks. Note, the charger can be programmed to limit output amps see **Section XII** for description of use, and **Custom Programming, Section VIII** for programming instructions.
- 3) Charger Mode:** Displays "ON" or "OFF". This effects only the output of the charger and does not control AC input. When set to off position AC is still live inside the unit. Factory default setting is "OFF" see **Section V** for activation instructions.

When in on mode the charge cycle status will also be displayed i.e. BULK, ABOSRBITION, or FLOAT. See **Section VII** for description on each of these charge modes.

- 4) Battery Temp:** Displays sensed temperature at the battery when optional temp probes are installed. Note screen will display "N/A" unless battery temp probes per battery bank have been enabled as described in **Section X**. Fahrenheit is factory default or select Celsius scale using set up programming as described in **Section V**.

Alarm Notifications

When alarm condition is sensed, the status screen will display condition in Red text, indicator light turns red, and audio alarm will sound. Press any key to silence alarm. Here is example of the AC fail condition alarm screen:

Figure 4.2: Alarm Screen

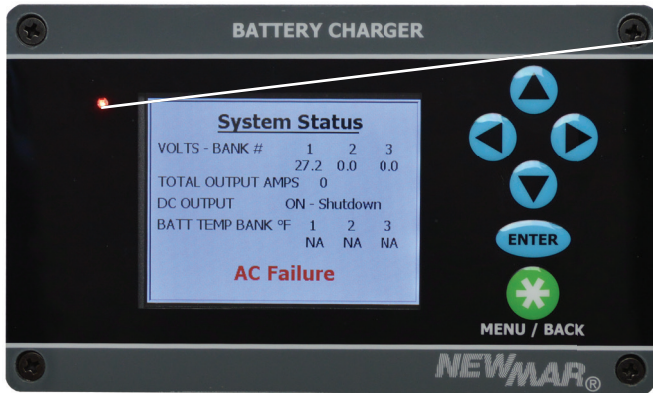

Indicator light illuminates Red for AC Failure.

Indicator light illuminates Amber for all other alarm conditions.

A list follows of alarm notification conditions, see **Section IX** for detailed description of all alarm condition and remedies.

- AC Fail
- Charger Over Temp
- Battery Over Temp
- High Charger Output Voltage
- Low Charger Output Voltage
- Internal Power Module Over Temp
- Power Module Failure
- Output Fuse Failure
- Controller Comm Error

Status Indicator light

The indicator light to the left of the text screen will change state per the following conditions.

Any Alarm condition turns indicator light RED.

AC Conditon	Charger State	Battery Connection	Ind. Light
connected	on	connected	green
connected	off	connected	green
connected	on	disconnected	green
connected	off	disconnected	green
disconnected	on	connected	red
disconnected	off	connected	red
disconnected	on	disconnected	red
disconnected	off	disconnected	off

SECTION V: Initial Start-Up/Default Settings/Adjustments

1) Charger On-Off Setting

In the factory default setting, the charger mode is Off. Note in this condition, there is no effect to AC inputs when AC input is live changing DC output status to On or Off does not energize or de-energize the internal AC circuits.

To change charge mode settings:

2) DC Output ON-OFF Control

To Change Status from "Charger Mode" screen.

System Status

VOLTS – BANK#	1	2	3
	22.5	23.4	21.6
TOTAL OUTPUT AMPS	120		
DC OUTPUT	ON-BULK		
BATT TEMP BANK °C	1	2	3
	30	25	28

Press "Menu/Back" to go to "View/Change Settings" screen.

View / Change Settings

DC Output ON – OFF

Battery Type=

Float Voltage =

Absorption Voltage=

Bank Volts Displayed

Batt Temp Enabled

Absorption End Time Out

Press ▲ and ▼ buttons to highlight charger on-off status line which will have gray background.

Press "Enter" which takes you to

Status Change Screen

Set Charger ON / OFF

DC Output ON

DC Output OFF

Press ▲ and ▼ buttons to select highlight condition.

Press "Enter" which returns you to "System Status" screen indicating DC output is on.

3) Set-Up Functions/Calibrations

- Temp units F/C
- Battery Bank Volts
- Temp Comp Enable
- Max Charge Amps

A) To set temperature units F/C (F default)

From System status screen press "Menu/Back"
Takes you to the "View/Change Settings" screen

Use the ▲ and ▼ buttons to highlight this option and press "Enter". You will then see the "Set Temp Units" screen.

Use the ▲ and ▼ buttons to select your choice. Once your choice is set press "Enter", you will return to the "View/Change Settings" screen and your choice will now be displayed.

To save this choice press "Menu/Back" you will see the "Save Data" screen, yes will be highlighted to save just press "Enter".

You will see a confirmation that your configuration was saved successfully and be returned to the "System Status" screen.

B) To Set Battery Bank Volts (to be displayed)

From "System Status" screen press "Menu/Back". Takes you to the "View/Change Settings" screen

use the ▲ and ▼ buttons to highlight this option and press "Enter"

You will then see the "Bank Volts=1,2,3 Displayed on Status Screen" screen, Use the ▲ and ▼ buttons to select your choice

The battery bank selected the word "Enabled" will be darker, press enter to enable and you will see a check in the box to show that you have enabled this bank.

Repeat this process for each bank to be enabled

Once your choice is set press "Menu/Back", you will return to the "View/Change Settings" screen and your choice will now be displayed.

To save this choice press "Menu/Back" you will see the "Save Data" screen, yes will be highlighted to save just push "Enter"

You will see a confirmation that your configuration was saved successfully and be returned to the "System Status" screen

C) To Set Battery temperature enabling

From System status screen press "Menu/Back"

Takes you to the "View/Change Settings" screen. Use the ▲ and ▼ buttons to highlight this option and press "Enter". You will then see the "Batt Temp Enable" screen. Use the ▲ and ▼ buttons to select your choice

The battery bank selected the word "Enabled" will be darker, press enter to enable and you will see a check in the box to show that you have enabled this bank

Repeat this process for each bank to be enabled

Once your choice is set press "Menu/Back", you will return to the "View/Change Settings" screen and your choice will now be displayed.

To save this choice press "Menu/Back" you will see the "Save Data" screen, yes will be highlighted to save just press "Enter"

You will see a confirmation that your configuration was saved successfully and be returned to the "System Status" screen

Note: Temp Probes needs to be installed on any enabled input otherwise, DC output will be disabled and alarm will sound.

D) To Set Max Charge Amps

Output current limit rate is programmable from 50 to 100% of 10 amp capacity. This allows:

- 1) Setting to meet battery capacity requirement
- 2) Limiting input AC current to match shore power input capacity, preventing tripping the shore power breaker.

AC Input Current Draw Output Amps at			
Input	50A	75A	100A
230V AC	9	13	17
115V AC	13	20	23

From System status screen press "Menu/Back". Takes you to the "View/Change Settings" screen. Use the ▲ and ▼ buttons to highlight this option and press "Enter". You will then see the "Max Charge Amps" screen.

Set Max Charging Amps

xx Amps

Use the ▲ and ▼ buttons to select the value, note each of the three digits is set independently use the ◀ and ▶ buttons to select the digit to change. Once your choice is set press "Enter", you will return to the "View/Change Settings" screen and your choice will now be displayed.

To save this choice press "Menu/Back" you will see the "Save Sata" screen, yes will be highlighted to save just press "Enter".

You will see a confirmation that your configuration was saved successfully and be returned to the "System Status" screen.

SECTION VI: Overview of Charger Program Options

Table 6.1:

View/Change Setting Screen Display Line Function	Default Condition	Programmable to	Programming Instructions, See Section
DC Output	Off	On/Off	V
Float Voltage	27.2	26.2 to 27.4	VIII
Absorption Voltage	28	27.6 to 29.0	VIII
Banks Volts Displayed	1	1,2,3	V
Battery Temp. Enabled	<blank>	1,2,3	X
Absorption End Time Out	2H	0 - 12	VIII
Absorption End Amps	10A	5 - 20A	VIII
End Absorption Condition	Timer Only	Timer Only, or Amperage and Timer	VIII
Bulk Stage End Time Out	10H	0 - 10 Hours	VIII
Max Charge Amps	100 Amps	50 - 100 Amps	V & VIII
Temperature Units (F/C)	C	F/C	V
Battery Type *	Gel	Gel, Flooded, #1, Flooded #2, AGM, TPPL, Custom	VII

* Table 6.2: Factory Default Settings Per Battery Type

Battery Type	Gel*	Flooded #1	Flooded #2	AGM	TPPL	Custom
Settings						
Float	27.2	26.8	27.0	27.2	27.0	25.0
Absorption	28.0	28.4	29.4	28.4	29	25.0
Absorption End Time Out* (Hrs.)	2	4	6	4	4	2
End Absorption-to-Float Amps	10A	10A	10A	10A	10A	10A
End Absorption Condition	Time Only	Time Only	Time Only	Time Only	Time Only	Time Only
Bulk Stage Time Out** (Hrs.)	10	10	10	10	10	10

SECTION VII: Battery Type Charge Program Selection and Adjustments

Battery Type Charge Program Selection and Adjustment

1) Available preprogrammed settings:

- Gel, Flooded #1, Flooded #2, AGM and Thin Plate Lead (TPPL)
- In addition, specific settings within each program can be modified*: See 2
- Or any setting can be changed via custom programming mode.
- Default setting: Gel

(See Section VIII for Custom Settings)

To Select Preprogrammed Battery Type:

From System Status Screen, press "Menu/Back". Takes you to "View/Change Setting" screen

Use ▲ and ▼ buttons to select (highlight) battery type line, press "Enter". Takes you to "Battery Type" selector screen.

View / Change Settings

DC Output ON – OFF
Battery Type=
Float Voltage =
Absorption Voltage=
Bank Volts Displayed
Batt Temp Enabled
Absorption End Time Out

Use ▲ and ▼ buttons to highlight battery type, press "Enter"

Set Battery Type

Gel
Flooded #1
Flooded #2
AGM
TPPL
Custom

Note, see Section VI for Default Voltage Settings Per Battery Type

Press "Menu/Back" to return to "View/Change" settings screen where selected battery type will be displayed.

Press "Menu/Back" to confirm setting. The "Save/Data" screen will appear.

Press "Enter" to save your selection, the screen will confirm that your value has been saved and return you to the "System/Status" screen. If you do not want the choice displayed, use the ▼ button to select "No" and press "Enter". You will return to the "System Status" screen with the previous setting unchanged.

2) Certain Parameters Within Preprogrammed Battery Type Can Be Changed:

Float voltage, absorption voltage, absorption end time out, absorption end amps, end absorption condition, bulk stage time out, equalize volts and end equalize. Other settings are locked in the preprogrammed mode but can be changed in the custom settings process (see **Page VIII-1**).

To Adjust Absorption End Time Out

From "System Status" screen, press "Menu/Back" to go to "View/Change Settings" screen.

Use the ▲ and ▼ to select (highlight) this option and press "Enter", takes you to the "Set Max Time in "Absorption Stage" Screen".

Set Max time in Absorption Stage

xx Hours

Use ▲ and ▼ to select the value in hours, note each of the two digits is set independently, use the ◀ and ▶ to select (highlight) the digit position you wish to change.

Once your choice is set, press "Enter", you will return to the "View/Change Settings" screen and your choice will now be displayed.

To save this choice, press "Menu/Back", you will see the "Save Data" screen, yes, will be highlighted, press "Enter" to confirm.

You will see a confirmation that your configuration was saved successfully and be returned to the "System Status" screen.

To Adjust Bulk Stage Time Out

From "System Status" screen, press "Menu/Back". To go to "View/Change Settings" screen, use the ▲ and ▼ to highlight this option and press "Enter". Takes you to the "Bulk Stage Time Out" screen:

Bulk Stage Time - Out

xx Hours

Use the ▲ and ▼ to select the value in hours, note each of the two digits is set independently, use the ◀ and ▶ to select the next digit to change. Once your choice is set, press "Enter", you will return to the "View/Change Settings" screen and your choice will now be displayed.

To save this choice, press "Menu/Back", you will see the "Save Data" screen, yes, will be highlighted, press "Enter" to confirm.

You will see a confirmation that your configuration was saved successfully and be returned to the "System Status" screen.

To Change End Absorption Stage Condition

From "System Status" screen, press "Menu/Back". To go to "View/Change Settings" screen, use the ▲ and ▼ to highlight this option and press "Enter". Takes you to the "Set Absorption Stage Condition" screen.

Set End of Absorption Stage Condition

Timer Only
Amperage and Time

Use the ▲ and ▼ to select (highlight) your choice either:

- Timer only (in this stage, the system will maintain the absorption voltage for the set time even with no load on the system).
- Amperage and Timer (in this stage, the system will shift to float voltage when either the amperage or time limit conditions is first reached).

Once your choice is set, press "Enter", you will return to the "View/Change Settings" screen and your choice will now be displayed.

To save this choice, press "Menu/Back", you will see the "Save Data" screen, yes, will be highlighted, press "Enter" to confirm.

You will see a confirmation that your configuration was saved successfully and be returned to the "System Status" screen.

To Change Absorption End Amps

From "System Status" screen, press "Menu/Back". Takes you to "View/Change Settings" screen. Use ▲ and ▼ buttons to select (highlight) this option and press "Enter". You will then see the "Set Minimum Amperage Acceptance Rate That Ends Absorption Stage" screen.

**Set Minimum
Amperage Acceptance
Rate that Ends
Absorption Stage**

XX. Amps

To save this choice, press "Menu/Back", you will see the "Save Data" screen, yes, will be highlighted, press "Enter" to confirm.

You will see a confirmation that your configuration was saved successfully and be returned to the "System Status" screen.

SECTION VIII: Custom Programming

The Custom battery settings program allows changes to all charge profile parameters :

Float voltage, absorption voltage, absorption end time out, absorption end amps, end absorption condition, bulk stage time out, bulk stage time out, equalize volts, end equalize time out, max charge amps (current limit),

See **Section XII** for detailed explanation of these charging functions

To activate Custom battery settings program:

To enter the custom settings program module:

From System status screen press "Menu * Back". Takes you to "View/Change Settings" screen

Use ▲ and ▼ buttons to select (highlight) battery type, press "Enter". Takes you to "Battery Type" selector screen.

Use ▲ and ▼ buttons to select (highlight) "Custom", press "Enter".

Set Battery Type

Gel
Flooded #1
Flooded #2
AGM
TPPL
Custom

Note, see Section VI for Default Voltage Settings Per Battery Type

Takes you to the view change settings screen.

1) To Set Float Voltage

use the up /down arrows to to highlight this option and press "enter"

Takes you to the "set float voltage" screen

Set Float Voltage

xx.x Volts

Use the up down arrows to select the value in volts, note each of the three digits is set independently use the left/right arrows to select the digit to change. Once your choice is set, push "Enter", you will return to the "View/Change Settings" screen and your choice will now be displayed.

To save this choice press "Menu/Back", you will see the "Save Data" Screen, yes will be **prompted** to save, just press "Enter". A confirmation that your configuration was saved successfully will be displayed and be returned to the "System Status" screen.

To set Absorption voltage

From System status screen press "Menu/Back". Takes you to the "View/Change Settings" screen. Use the ▲ and ▼ buttons to highlight this option and press "Enter". You will then see the "Set Absorption Voltage" screen

Set Absorption Voltage

xx.x Volts

Use the ▲ and ▼ buttons to select the value in volts, note each of the three digits is set independently use the ◀ and ▶ to select the digit to change

Once your choice is set press "Enter", you will return to the "View/Change Settings" screen and your choice will now be displayed.

To save this choice press "Menu/Back" you will see the "Save Data" screen, yes will be highlighted to save just push "Enter"

You will see a confirmation that your configuration was saved successfully and be returned to the "system status" screen

To Set Absorption End Time Out

From System status screen press "Menu/Back". Takes you to the to "View/Change Settings" screen. Use the ▲ and ▼ buttons to highlight this option and press "Enter". You will then see the "Set Max Time in Absorption Sage" screen

Set Max time in Absorption Stage

xx Hours

Use the ▲ and ▼ to select the value in hours, note each of the two digits is set independently use the ◀ and ▶ to select the digit to change. Once your choice is set press "Enter", you will return to the "View/Change Settings" screen and your choice will now be displayed.

To save this choice press "Menu/Back" you will see the "Save Data" screen, yes will be highlighted to save just press "Enter" You will see a confirmation that your configuration was saved successfully and be returned to the "System Status" screen

To set Absorption End Amps

From System status screen press "Menu/Back". Takes you to the to "View/Change Settings" screen. Use the ▲ and ▼ buttons to highlight this option and press "Enter". You will then see the "Set Minimum Amperage Acceptance Rate That Ends Absorption Stage" screen.

Set Minimum Amperage Acceptance Rate that Ends Absorption stage.

xx Amps

Use the ▲ and ▼ buttons to select the value in amps, note each of the two digits is set independently use the ◀ and ▶ buttons to select the digit to change. Once your choice is set press "Enter", you will return to the "View/Change Settings" screen and your choice will now be displayed.

VIII-2

To save this choice press "Menu/Back" you will see the "Save Data" screen, yes will be highlighted to save just press "Enter". You will see a confirmation that your configuration was saved successfully and be returned to the "System Status" screen

To Set End Absorption Stage Condition

From "System Status" screen press "Menu/Back". Takes you to the "View/Change Settings" screen. Use the ▲ and ▼ buttons to highlight this option and press "Enter". You will then see the "Set of Absorption Stage Condition" screen

Set End of Absorption Stage Condition

Timer Only
Amperage and Time

Use the ▲ and ▼ to select your choice either:

- Timer only (in this stage the system will maintain the absorption voltage for the set time even with no load on the system)
 - Amperage and Time (in this stage the system will shift to the float voltage if the output current falls to the set parameter before the set time out, once the set time is reached it will shift to float no matter what the current output is)
- Once your choice is select press "Enter", you will return to the "View/Change Settings" screen and your choice will now be displayed.

To save this choice press "Menu/Back" you will see the "Save Data" screen, yes will be highlighted, to save just push "Enter".

You will see a confirmation that your configuration was saved successfully and be returned to the "System Status" screen.

To Set Bulk Stage End Time Out

From System status screen press "Menu/Back". Takes you to the "View/Change Settings" screen. Use the ▲ and ▼ buttons to highlight this option and press "Enter". You will then see the "Bulk Stage Time Out" screen

Bulk Stage Time - Out

xx Hours

Use the up down arrows to select the value in hours, note each of the two digits is set independently use the ◀ and ▶ buttons to select the digit to change. Once your choice is set press "Enter", you will return to the "View/Change Settings" screen and your choice will now be displayed.

To save this choice press "Menu/Back" you will see the "Save Data" Screen, yes will be highlighted to save press "Enter" You will see a confirmation that your configuration was saved successfully and be returned to the "System Status" screen.

To Set Equalize Voltage

From "View/Change Settings" screen. Select "Equalize Volts", press enter taking you "Set Equalize Voltage" screen:

Set Equalize Voltage

xx.x Volts

Using ◀ and ▶ buttons on touch pad to select digit position, use ▲ and ▼ buttons to scroll to desired value. Repeat for all digit positions, then press "Enter", confirm the setting, which returns you to the "View/Change Settings" screen where the entered value will be displayed.

To Set Equalize Time

From "View/Change Settings" screen
Select "Equalize Time", press enter taking you "Set Equalize Voltage" screen:

Set Equalize Time

xx Hours

Using ◀ and ▶ buttons on touch pad to select digit position, use ▲ and ▼ buttons to scroll to desired value. Repeat for all digit positions, then press "Enter", confirm the setting, which returns you to the "View/Change Settings" screen where the entered value will be displayed.

To Start Equalize Cycle

From "View/Change Settings" screen
Select "Set Equalize Cycle", press enter taking you "Set Equalize Cycle" screen:

Set Equalize Cycle

Start
Cancel

Using use ▲ and ▼ buttons to scroll to select start or cancel then press "Enter", confirm the setting, which returns you to the "View/Change Settings" screen where the entered value will be displayed. Press "Menu/Back" to return to the system status screen where "Equalize Activated" and hours remaining in cycle will be displayed.

System Status

VOLTS - BANK#	1	2	3
	22.5	23.4	21.6
TOTAL OUTPUT AMPS	120		
CHARGER MODE	ON-BULK		
BATT TEMP BANK °C	1	2	3
	30	25	28

Equalize Activated
xx Hrs Remaining

To Set Max Charge Amps

Output current limit rate is programmable from 50 to 100% of 10 amp capacity. This allows:

- 1) Setting to meet battery capacity requirement
- 2) Limiting input AC current to match shore power input capacity, preventing tripping the shore power breaker.

From System status screen press "Menu/Back". Takes you to the "View/Change Settings" screen. Use the ▲ and ▼ buttons to highlight this option and press "Enter". You will then see the "Max Charge Amps" screen.

Set Max Charging Amps

xx Amps

Use the ▲ and ▼ buttons to select the value, note each of the three digits is set independently use the ◀ and ▶ buttons to select the digit to change. Once your choice is set press "Enter", you will return to the "View/Change Settings" screen and your choice will now be displayed.

To save this choice press "Menu/Back" you will see the "Save Sata" screen, yes will be highlighted to save just press "Enter". You will see a confirmation that your configuration was saved successfully and be returned to the "System Status" screen.

Section IX: PTMP Alarm Conditions

Operational sensors in the charger monitor vital conditions and when out of limit data is sensed a alarm notification will appear on the system information screen and a buzzer will sound. Press any button to silence alarm buzzer or else buzzer will continue until alarm condition is corrected. Three of these alarm conditions also activate separate form C alarm contact relays which will also export the alarm notice: AC Fail, DC Fail & System Fail.

AC Input Failure

System Status

VOLTS – BANK#	1	2	3
	22.5	23.4	21.6
TOTAL OUTPUT AMPS	120		
CHARGER MODE	ON-BULK		
BATT TEMP BANK °C	1	2	3
	30	25	28

AC Failure

Result: AC Fail Alarm contact also activated in this condition
Corrective Action: Check input breaker

Charger Over Temp

System Status

VOLTS – BANK#	1	2	3
	22.5	23.4	21.6
TOTAL OUTPUT AMPS	120		
CHARGER MODE	ON-BULK		
BATT TEMP BANK °C	1	2	3
	30	25	28

Charger Over Temp

Result: No output or reduced power
Corrective Action: Check filter, ambient temperature

Battery Over Temp

System Status

VOLTS – BANK#	1	2	3
	22.5	23.4	21.6
TOTAL OUTPUT AMPS	120		
CHARGER MODE	ON-BULK		
BATT TEMP BANK °C	1	2	3
	30	25	28

Battery # x Over Temp

Result: No output or reduced power
Corrective Action: Battery check, ambient temp check

High Charger Output Voltage

System Status

VOLTS – BANK#	1	2	3
	22.5	23.4	21.6
TOTAL OUTPUT AMPS	120		
CHARGER MODE	ON-BULK		
BATT TEMP BANK °C	1	2	3
	30	25	28

High Charger Voltage

Result: No charger output
Corrective Action: Replace modules (one or more is bad).
Contact factory

Low Charger Voltage

System Status

VOLTS – BANK#	1	2	3
	22.5	23.4	21.6
TOTAL OUTPUT AMPS	120		
CHARGER MODE	ON-BULK		
BATT TEMP BANK °C	1	2	3
	30	25	28

Low Charger Voltage

Result: Indication only
Corrective Action: Reduce load current

Internal Power Module Over Temp

System Status

VOLTS – BANK#	1	2	3
	22.5	23.4	21.6
TOTAL OUTPUT AMPS	120		
CHARGER MODE	ON-BULK		
BATT TEMP BANK °C	1	2	3
	30	25	28

Module # x Over Temp

Result: Module shut down (second module may still operate)
Corrective Action: Check for blocked intake air path and remove any obstructions. Replace module if conditions continues.

Power Module Failure

System Status

VOLTS – BANK#	1	2	3
	22.5	23.4	21.6
TOTAL OUTPUT AMPS	120		
CHARGER MODE	ON-BULK		
BATT TEMP BANK °C	1	2	3
	30	25	28

Module # x Failure

Result: Module shut down (second module may still operate)
Corrective Action: Replace module (See Section XI)

Output Fuse Failure

System Status

VOLTS – BANK#	1	2	3
	22.5	23.4	21.6
TOTAL OUTPUT AMPS	120		
CHARGER MODE	ON-BULK		
BATT TEMP BANK °C	1	2	3
	30	25	28

Output Fuse Failure

Result: No output
Corrective Action: Check for reverse polarity, correct polarity replace fuse. See Page XI-3 for replacement instructions

Controller Communication Failure

System Status

VOLTS – BANK#	1	2	3
	22.5	23.4	21.6
TOTAL OUTPUT AMPS	120		
CHARGER MODE	ON-BULK		
BATT TEMP BANK °C	1	2	3
	30	25	28

Control Comm Error

Result: No output
Corrective Action: Replace controller board (See Section XI)

SECTION X: Optional Configurations/Accessories: Temperature Compensation, Alarm Contacts, Remote Panel

1) Temperature Compensation Option

Because low battery temperature increases resistance to charging and high battery temperature reduces resistance, requiring a lower charge voltage, the ideal charging voltage will vary depending on the temperature of the battery's environment when it is being charged.

If a charger has a fixed output voltage which is ideal at, say 72° F that same output may cause a battery charged in consistently high temperature environment to be overcharged, resulting in excessive loss of electrolyte. Conversely, if the batteries are in a consistently cool environment, they may be chronically undercharged, resulting in sulfation of the battery plates. Either of these two conditions will shorten battery life.

Temperature Compensation Option (requires optional temperature sensors Model TP-PTMP, P/n 445-4129-1)

The PTMP has the option to be programmed to accept input from up to 3 different temperature sensors, and regulates output voltage based on the highest temperature input as this is the most critical to long battery life. If the temperature sensors are not utilized the charger will operate based on a 72° F (22° C) fixed reference point.

Note that the temperature compensation option must be activated per each of the inputs desired via the control panel, see **Section V: Page V-2**, for programming instructions.

The remote sensor will signal the charger to fine tune its output voltage so that it is properly matched to the temperature of the battery/battery environment. The adjustment rate is approximately -5 mV per cell per °C. (Note: The temperature compensation option is strongly recommended for sealed, valve-regulated, AGM or gel-cell batteries.

Each remote sensor is provided with 40' of cable. If additional cable length is required, the probe can be extended by splicing in two conductor, 20 AWG stranded wire.

The sensor(s) themselves should be mounted on the inside of the battery box, or more ideally, mounted onto one of the batteries using a clamp or a small amount of silicone-type adhesive.

Important Note: When wiring multiple chargers in parallel (see Section III) and using the temperature compensation option and the sensors must be mounted close together in the same battery box or on the same battery for proper operation.

An identical number of sensors must be installed for each charger. Without the temperature sensor installed, the output of the charger will be at the nominal voltages specified in the chart below at 72° F (22.2° C). The absorption/float output voltage settings at that temperature are listed in the chart.

To provide some examples which clarify the effect of the temperature compensation sensor, the chart in **Section VI** lists the absorption/float output voltages of the charger when batteries are at 72° F (or when the sensor is not installed), and at cold (50° F) or hot (90° F) battery temperature with the sensor installed.

Temperature Compensation Sensor Installation

Requires optional PTMP model TP-PTMP Temperature Compensation Sensor, Part No.: 445-4129-1

Tools required:

- Phillips #2 screw driver
- Slotted 3/32" screw driver (Newmar screw driver with 1/16" wide slotted bit included in manual bag)
- Wire stripper/cutter
- Silicone/RTV (attach sensor end to battery)

CAUTION: Install temperature compensation sensors before connecting batteries or AC power to battery charger.

1. Installing temperature sensor to battery bank:

The PTMP charger will identify up to three battery temperature sensors so we recommend placing a piece of tape on the un-terminated wire ends identifying Bank 1, Bank 2 & Bank 3 sensors. Install the sensor inside the battery box or more ideally, mounted on to one of the batteries using a small amount of silicon-type adhesive.

2. Connecting temperature sensor to PTMP charger:

Note: If AC power & batteries are already connected:

- A. Ensure AC circuit breaker feeding the charger is in the OFF position and verify the red 'AC Present' indicator on bottom plate is Not illuminated.

- B. Disconnect batteries-remove negative/bonding cable form chassis ground stud on left hand side of charger if connected. Then remove battery negative/Common followed by Battery + of each Bank connected.
3. Open front panel of charger, see **Section III**.
 4. Two cord grips are provided on the right hand side cord grip plate for the following options:
 - A. Battery temperature compensation sensor wiring (1,2 or 3 sensors)
 - B. Alarm contact wiring
 - C. Display cable (when remote mounting display)
 5. Remove the right hand side AUX access plate plate by removing the four Phillips head screws, see **Figure 10.2**. Choose and install one of the cord grips in the panel (small size if only routing temperature compensation sensor cables through the cord grip) and then loosen the pressure dome nut on the cord grip. Run the un-terminated ends of the temp probe cables (two conductor cable) through the cord grip and into the battery charger. Route the cables to the green six position connector at the edge of the control board identified as mounted to the right side of the charger, see **Figure 10.1**.

Figure 10.1: Temp Sensor Connection Points

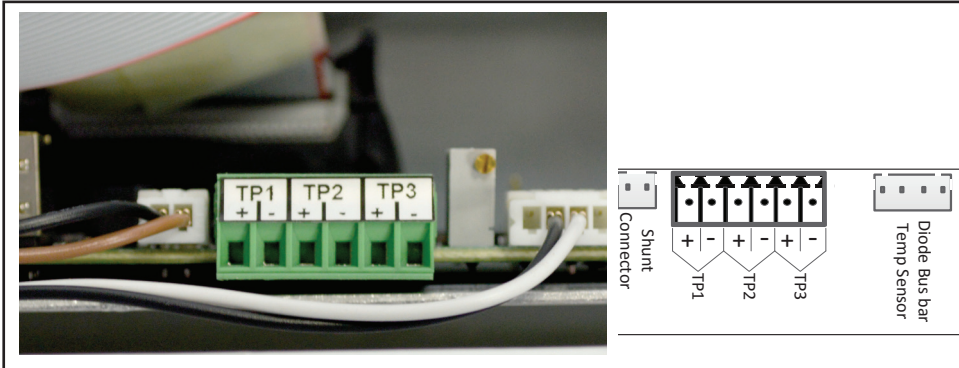

Note: The Status Screen identifies each battery temperature compensation sensor as 1, 2 or 3

6. Remove 1/4" of insulation from the temperature sensor wire ends (2). Un-plug the green 6 position connector from the controller board, see **Figure 11.1**. Loosen terminal screws using a and attach temp probe #1 wires to connector position no.1 paying close attention to wire color and polarity:
 - WHITE: +
 - BLACK: -
 Repeat for battery temperature compensation sensor no.2 & no.3
7. Plug the 6 position connector back in to the mating connector. Dress wires so not to interfere with cover seal. Note: the connector will plug in to mating connector one way only. Re-install cord grip plate. Ensure wires do not get pinched between plate and chassis
8. Pull up on the cover slightly, lift the front panel stay to un-lock it and slowly lower the front panel down and secure the two side latches.
9. Re-connect cables/AC Power:
 - A. Re-connect the battery Positive (+) cables followed by the chassis bonding cable (if attached) and the battery negative/common cable.
 - B. Turn the battery charger AC input circuit breaker back to ON and do the following:
 - 1) Wait until the main screen is displayed then press the "Menu/Back" key
 - 2) Use the arrow keys to select the "Batt Temp Enabled" then press the "Enter" key to enter temp probe setup menu.
 - 3) Use the "Enter" and up and down arrow keys to select the appropriate temp probe (a check in the box will indicate probe selection).
 - 4) Once all battery temp probes have been selected press the "Menu/Back" key twice to exit menus, select "Yes" then press the "Enter" key to save the settings.

Alarm Contacts

The charger has built-in alarm relay contacts that report out of limit AC and DC conditions. When these relays activate, a visual diagnostic alarm message will appear on the display and remain until condition is corrected. An audio alarm will also activate. Press any button to silence the alarm. If not manually silenced, the audio alarm will continue to sound until alarm condition is reset.

Alarm Conditons:

- 1) AC Fail: activates when input voltage drops below 75V AC
- 2) DC Fail: Contact Activate With:
 - A) Module Failure
 - B) DC Fuse Failure
- 3) Controller Communication Fail: Contacts Activate With
 - A) No power from battery or modules (control PCB power is down)
 - B) Firmware failure (micro-controller)

Wiring

To connect to these contacts, open the front panel, see **Section III**. Remove the AUX wiring access plate on the bottom right of the panel of charger, see **Figure 10.2**. Secure a cord grip/strain relief (provided) to the access hole in the bottom panel of the charger and route your alarm wiring through and into the cavity of the unit and snake the cable to the alarm contact terminal block, see **Figure 10.3**. The cord grips will accommodate the following wire diameters.

Small: 0.2" - 0.5"
Large: 0.35" - 0.7"

Figure 10.2

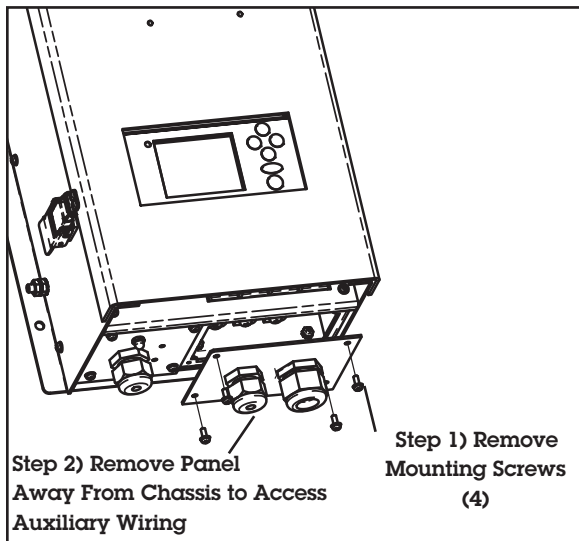

Located the terminal block identified in **Figure 10.4**. The labeled portion of this block can be removed to facilitate alarm wiring connection. Unplug the labeled portion and make your alarm contact wiring connections by loosening the screws and inserting the wires and securing the screws. Re-connect the plug to the control board and dress the wires so there is no stress on the control board.

Figure 10.3: Alarm Contact Points

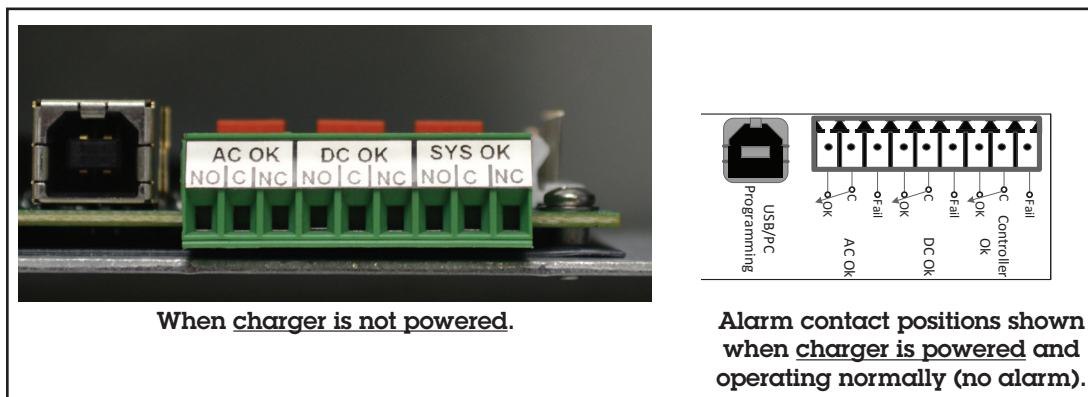

Remote Installation of Display Panel/Key Pad

The display/keypad located on the front panel of the charger can be removed and installed as a panel in a remote location. This requires a remote mounting kit (PN: 445-1200-0) which includes complete instructions, extension cable, rubber gasket, and a blanking panel to cover the opening where the display was removed.

Figure 10.5: Remote Panel

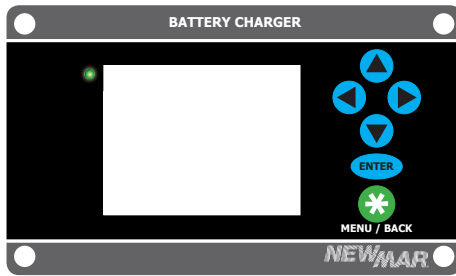

Remote Panel, P/N: 447-5801-0

SECTION XI: Maintenance and Component Replacement

Filter Maintenance and Electronic Component Replacement

There are several user serviceable components within the charger that do not require a technician to replace, basic mechanical skills is all that's required. These components include:

- Air filter media cleaning/replacement
- Power Module replacement
- Control board replacement
- Output fuse replacement

Air Filter Replacement

An air filter media is located in the upper portion of the inside the charger that should be cleaned/replaced periodically. The frequency of service is determined by the nature of the operating environment, the more dust, oils etc. in the circulating air the more frequent the cleaning will need to be. Signs of a dirty filter include reduced output power, or complete shut down and recovery cycling due to high internal temperature that cannot be ventilated due to the filter blockage. This occurrence will cause over temperature alarm condition to be displayed on system status screen.

To access the filter, open the front panel of the charger, see **Page III-1** for instructions. The filter assembly is at the top of the charger cavity encased in an removable aluminum bracket and is identified by a call out label. Pull and slide out the assembly from the retaining grooves. Remove the filter media from the bracket and either clean or replace with new.

Note, two spare filter media is included in the manual bag. If you need more contact Newmar and we will ship you at no charge. Call 800-854-3906 or E-mail techservice@newmarpower.com and request P/N: 447-3030-0.

You may want to make a journal notation of how often you change/clean the filter and note dirt build-up and adjust internal replacement accordingly.

Power Module Replacement: Note DO NOT REMOVE both modules at same time when batteries connected - control board will be damaged.

The charger contains two power internal power modules rated at 50 amps output each. Should a module fail an alarm notification will appear on the system status screen identifying which module a buzzer will also sound. (Press any key to silence buzzer - Module #1 on the Right and Module #2 on the left).

Note: the power modules function independently of each other so a failure in one does not cause entire system shut down, the charger will continue to operate but at half power rating.

The modules are designed for easy replacement by non-technical personnel without having to remove the charger from the vessel. Modules cannot be field repaired so its recommended you have replacement on hand when the defective is removed. Specify part number P/N: 447-2450-0 when ordering replacement from your Newmar distributor.

Follow this replacement procedure:

- 1) Shut off AC power to the charger, confirm that the input power indicator light on the bottom panel is not illuminated
- 2) Open front panel of charger, see **Page III-1** for instructions.
- 3) Locate bad module as was identified on the alarm screen (Module #2 on left, #1 on right). Note: Do not remove both modules with batteries connected. This could damage the control board.
- 4) Locate retaining arm at top of power modules which holds them in vertically place, and loosen retaining screw until the arm is freed, rotate arm to the left, see illustration on next page.

Figure 11.1: Air Filter Replacement



Figure 11.2

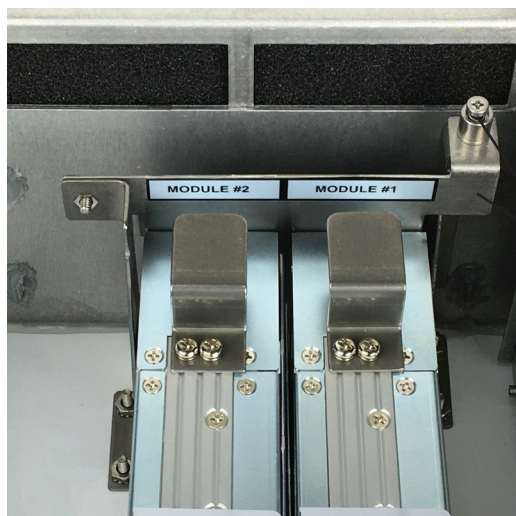

Module Retaining Bar & Screw

- 5) Grab the handles on the bad module, lift up toward the top of the charger releasing the module from the connectors at the bottom of the unit, and then tilt out and pull the module away from the charger.
- 6) Insert the replacement module, angling in at the connector end at the bottom and pushing vertical and then applying force down to ensure the electrical connections are properly seated.
- 7) Swing the retaining arm back into position and secure in place, making sure the retaining screw is snug. Note the modules will appear loose even after the vertical retaining arm is in place. The modules are held in place horizontally when the front panel cover is secured and latched in lock position.
- 8) Close and latch front panel of charger
- 9) Restore AC to unit and confirm the module fail alarm has cleared.

Control Board Replacement

If it is determined that the control board is defective as notified by "Comm Error" alarm on status screen, it can be replaced while the charger remains installed:

Replacing the board will erase any custom settings you have entered. It is recommended that you scroll through and record the values in the settings menu for reference when reprogramming, see **Section IV** for instructions on how to view all settings.

- 1) Shut off AC power to the charger, confirm that the input power indicator light on the bottom panel is not illuminated
- 2) Open front panel of charger, see **Page III-1** for instructions.
- 3) The control board is located on the right side of the charger cavity and has several connectorized plug in wire assemblies attached to it. It is recommended that these connections be removed after the circuit board has been removed.
- 4) Locate the board retaining brace and screw that holds it in place. Loosen screw (it will remain captured), and carefully rotate the board upwards and out of its slot, see **Figure 11.3**.
- 5) It is recommended that you take a picture of the circuit capturing position of all optional wires you may have added for your application. For reference when reinstalling the wires. Then Remove the wiring connectors from the circuit board. Here is basic list of wires that need to be removed:

Figure 11.3



Control Board Retaining Screw

Standard Factory Wiring:

- 2 ea. Module Ribbon Wiring
- 1 ea. Fan Control
- 1 ea. Display Output
- 1 ea. Diode Bus Bar Temp. Sensor
- 1 ea. Shunt

Optional Wires:

- Alarm contacts (plug)
- Battery temperature sensor (plug)

- 6) Reconnect the inputs to the board and re-install in reverse order.
- 7) See **Section IX** for instructions to adjust programs from factory default.

Output fuse replacement

If the charger is subjected to reverse polarity it will protect itself by clearing the Reverse Polarity fuse and the status screen will display alarm warning "Output Fuse Failure". The output fuse (HBO type 125 amp rating) is located beneath the status screen on the front panel.

- 1) Shut off AC power to the charger, confirm that the input power indicator light on the bottom panel is not illuminated
- 2) Disconnect all battery wires to the charger.
- 3) Open front panel of charger, see **Page III-1** for instructions.
- 4) Remove the status screen from its position by removing the 4 corner screws and lift the screen assembly out of the way.
- 5) Locate fuse in left side of cavity below meter window, see **Figure 11.4**.

Figure 11.4

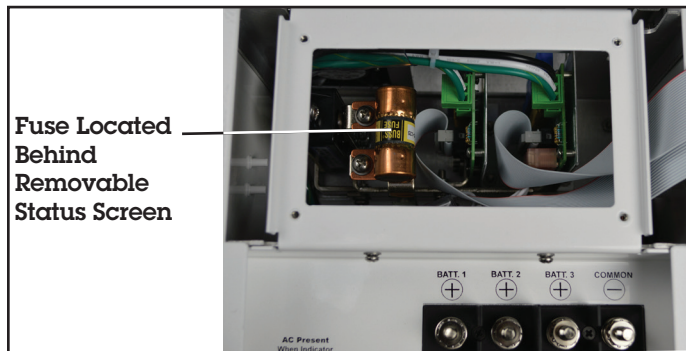

- 5) Using a Philips screw driver, loosen but do not remove the fuse retaining hardware. Slide the fuse off and replace with like.
- 6) Reassemble in reverse order.

SECTION XII: Three Stage Charge Regimen

The PTMP utilizes a three stage charge regimen which is widely recommended by battery manufacturers to provide faster and fuller recharge without loss of batteries' electrolyte (gel or liquid) which may be caused by sustained charging at high voltages.

The parameters that control each of these three stages change depending on the battery type selected, see **Section V** for battery type choices, default settings, and custom programing details/information.

The three stage regimen is initiated each time AC power is applied, proceeds slowly or quickly through each of the three stages depending on the battery's relative state of charge, as follows:

1) Bulk Phase: When batteries are significantly discharged the charger responds initially to rapidly replenish by delivering a high amount of DC current, (up to the charger's rated or programmed current limit), based on the batteries acceptance of current which is a function of internal impedance. During this stage that charging current is maintained at a high level as battery voltage increases. Bulk charging continues until battery voltage reaches the Absorption voltage point (where batteries are at about 75-80% of capacity) and the charger then shifts into that stage (see item 2).

If loads are applied to the battery during the bulk stage, this can extend the time it takes to reach the absorption point. If loads are high enough, the time interval can be extended to the point where absorption voltage is nearly attained but the high current demand keeps the charger in the bulk stage, which could cause damage to the battery cells. Therefore the bulk function has a time-out program that will prevent batteries from overcharging if the amperage output remains high due to the loads on the battery. The factory default time interval is 10 hours and can be modified under the custom programing process, see custom settings **Section VI**.

2) Absorption Phase: During this second stage of the charge cycle, battery voltage is maintained at the "absorption" voltage level. Output current begins to taper off as the battery plates become saturated. Absorption voltage is maintained until sensed conditions shift the output to the float stage. There are two programmable conditions that end absorption stage: time and current, both values are user adjustable, and user may also select the trigger factor: time or time or current. The factory default trigger is time, set at 2 hours, the amperage trigger default setting is 10A, but must be enabled to act on the charger. See **Section VI** for programing details.

3) Float Phase: For extended battery life the PTMP then automatically switches to a lower float voltage level. This float charge keeps batteries at a safe operational voltage without overcharging. The charger may be left in this stage for lengthy periods of time without attention (though periodic checks of electrolyte level in flooded batteries is recommended). It is not necessary or recommended to shut the charger off when this stage is reached. Float voltage varies per battery type selected, and is user adjustable, see **Section VI**.

A typical three stage charging cycle is illustrated in **Figure 12.1**.

Figure 12.1: Typical Charger Output Graph (into battery without load)

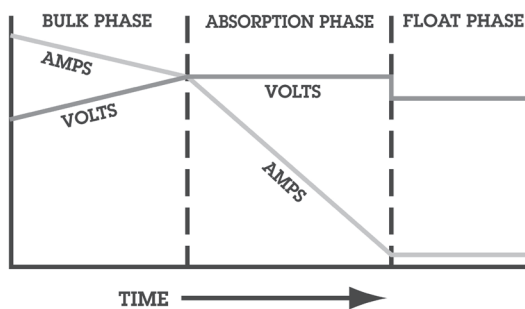

Equalization Program: The equalization stage is essentially overcharging cells for a limited interval and should only be performed with caution and based strictly on the battery manufacturers recommendation and guidelines. Not all batteries may be subjected to equalization voltage. The batteries should not be left unattended during this phase and the process should be stopped if the batteries get excessively hot. See **Section VIII** for enabling the equalization cycle.

Section XIII: Trouble Shooting

1) Status screen displays alarm condition when system is power up

1) Normal to occur when battery not connected

2) Status screen blank

2-a) In sleep mode, press any button to activate

2-b) Controller Failure. Open front of charger and if blinking light is not present on circuit board, replace board

XIII-1

SECTION XIV: Specifications (PTMP 24-100)

Input Voltage/Frequency: 90-264V AC; 47-63 Hz, single phase

Power Factor: .97 @ 230Vac @ Full Load

Efficiency: 90.5 %

Input Current @ Full Load: 17 amps @ 230V AC; 26 amps @ 115V AC

Output Current: 100 amps maximum in Bulk/Absorption/Float Phase Via 2 internal 50 amp power modules.

Adjustable Current Limit: 50 % to 100 % of maximum.

Line/Load Regulation: +/- 0.5%

Ripple: 200 mv p-p

Output voltages* per selected battery type:

Table 14.1

View/Change Setting Screen Display Line Function	Default Condition	Programmable to	Programming Instructions, See Section
DC Output	Off	On/Off	V
Float Voltage	27.2	26.2 to 27.4	VIII
Absorption Voltage	28	27.6 to 29.0	VIII
Banks Volts Displayed	1	1,2,3	V
Battery Temp. Enabled	<blank>	1,2,3	X
Absorption End Time Out	2H	0 - 12	VIII
Absorption End Amps	10A	5 - 20A	VIII
End Absorption Condition	Timer Only	Timer Only, or Amperage and Timer	VIII
Bulk Stage End Time Out	10H	0 - 10 Hours	VIII
Max Charge Amps	100 Amps	50 - 100 Amps	V & VIII
Temperature Units (F/C)	C	F/C	V
Battery Type *	Gel	Gel, Flooded, #1, Flooded #2, AGM, TPPL, Custom	VII

*** Table 14.2: Factory Default Settings Per Battery Type**

Battery Type	Gel*	Flooded #1	Flooded #2	AGM	TPPL	Custom
Settings						
Float	27.2	26.8	27.0	27.2	27.0	25.0
Absorption	28.0	28.4	29.4	28.4	29	25.0
Absorption End Time Out* (Hrs.)	2	4	6	4	4	2
End Absorption-to-Float Amps	10A	10A	10A	10A	10A	10A
End Absorption Condition	Time Only	Time Only	Time Only	Time Only	Time Only	Time Only
Bulk Stage Time Out** (Hrs.)	10	10	10	10	10	10

*Nominal Output Voltages (without Temperature Compensation option installed or at 22.2 °C with Temperature Compensation option installed):



Programming: via front panel touch pad:

Battery Temperature Compensation variation (with Sensor Installed): - 5 mV per cell per °C

Temperature Rating: -30° C to +70° C; Derate linearly from 100% (80% @ 115 vac) @ 50°C to 50% @ 70°C

Recommended Battery Type/Capacity: Gell-Cel, Flooded or Sealed Lead-Acid. TPPL

12 Cell, 180-950 Amp-Hour

Protection Features: Input Fuse, Output Fuse, Current Limiting, Over Voltage Protection, Cooling Fans, Automatic Thermal Shutdown/Recovery, IP 45

Indicators/Alarms

Status Screen: Volts (per bank), total amps, charge mode, battery temperature,

On screen Alarm notifications: AC fail, charger over temp, battery over temp, high charger voltage output, low charger voltage output, internal power module over temp, Internal module failure, fan failure, output fuse failure.

Indicator Light: Red/green

Alarm contacts, Form C: AC Fail, DC Fail & Controller Fail

Compliance: Designed to UL 60950-1, CE Mark & ABS (pending)

Mechanical

Field Serviceable Components: power modules, control board, display, output fuse, fan, air filter

IP Rating: 45

Mounting: Bulkhead

Cable Access: bottom panel

Case Size: 23.76"(H) x 10.07" (W) x 7.79" (D); Centimeters: 60.36 cm (H) x 25.58 cm (W) x 19.79 cm (D)

Weight: 28 lbs.; 12.7 Kg

Finish: Powder coated stainless and aluminum

Options:

Battery Temperature Compensation Probe: Model: PTMP-TP (P/N: 445-4129-1)

Display Remote Mounting Kit: P/N: 445-1200-0

Spare Parts:

Spare Filter, P/N: 447-3030-0 (qty. 3)

DC Output Fuse, HBO-125 (125 Amp), P/N: 562-1251-0

Outline Drawings

