

Battery Shelf and Module System

**Shelf Model:
BMS-19/23**

**Battery Module Models:
BM-48-4
BM-24-8
BM-12-16**

INSTALLATION/OPERATION MANUAL

I) OVERVIEW

The **BM Series Battery Module** with **BMS Shelf**, provides a complete plug-and-play battery system in one low profile 2RU (3.5") unit. It eliminates the need to assemble multiple batteries, trays, interconnect cable, terminals, lugs, etc. All are provided in an easy-to-assemble rackmount unit.

The system comprises a Battery Shelf that accommodates one or two installed 48 VDC, 24 VDC or 12 VDC Battery Modules. The shelf and modules are sold separately.

The battery modules slide easily into the shelf after installation and are held in place with a rear snap-lock mechanism and front panel latch. Provided connector assemblies enable quick parallel connection of both modules at the rear of the shelf, as well as parallel "daisy-chaining" of multiple BM/BMS systems in a rack for even higher reserve capacity.

The BM's internal batteries are sealed, maintenance-free with a 3-5 year typical (standby) life. They are IATA and DOT certified for shipment by air. The input/output connectors to the Battery Module are keyed to prevent reverse polarity hook-ups. A circuit breaker/switch controls output and protects internal wiring.

Mounting brackets provided with the battery shelf adapt for both 19" and 23" racks, 6" forward mount configuration. Flush (cabinet) shelf mounting and "universal" mounting of individual modules are also available as installation options (see Installation section).

II) BMS (BATTERY MODULE SHELF) INSTALLATION

A) Materials

Check to see that each of the following items have been included with the BMS packaging. For any missing items please contact the factory.

(1 ea.) Battery Module Shelf (empty; Modules sold separately)

M-BM-SERIES

1

- (2 ea.) Mounting Brackets for 19" Rack, Fixed (Stamped 13917 D)
- (2 ea.) Mounting Brackets for 19" Rack, Adjustable (Stamped 13917-1)
- (2 ea.) Mounting Brackets for 23" Rack, Fixed (Stamped 13918 C)
- (2 ea.) Mounting Brackets for 23" Rack, Adjustable (Stamped 13918-1)
- (6 ea.) Black Oxide Screws, 6-32 x 5/16"
- (6 ea.) # 6 Stainless Steel Splitlock Washers
- (6 ea.) Stainless Steel Screws, 8-32 x 5/16"
- (6 ea.) # 8 Stainless Steel Splitlock Washers

B) Mounting

The BMS has been designed for two different mounting options; **1)** 19" and 23" relay rack mount, **2)** Cabinet (flush) mount. Hardware for relay rack mounting is included with the BMS. (Contact the factory if the cabinet mounting option is required. Request model RSB-19 or RSB-23.)

1) Relay Rack Mount: The BMS is provided with two sets of four mounting brackets suitable for relay racks with 3" EIA channel/rails; one set is for 19" racks, the other for 23" racks. Each set consists of two "fixed" and two adjustable brackets.

The fixed brackets have round chassis attachment holes and accommodate three each 6-32 x 5/16" pan head phillips screws (provided). Attach these first in the front position as shown in FIGURE 1 below, then mount the BMS onto the rack on the front side of the rail.

The adjustable brackets have slotted chassis attachment holes and accommodate three each 8-32 x 5/16" pan head phillips screws (provided). Attach them loosely to the BMS chassis in the rear position as shown in FIGURE 3, then secure the brackets to the rear of the rail. Finally, tighten the chassis attachment screws. The holes on the brackets are slotted to adjust for racks with slightly differing front-to-rear rail dimensions.

Note: This dual bracket installation is for 6" forward mounting only . Flush mounting is typically used in a cabinet installation (see option 2, next page). Due to the weight of the BMS, 6" forward mounting is the *only* recommended configuration for relay rack installations.

FIGURE 1: Relay Rack Mounting Bracket Installation

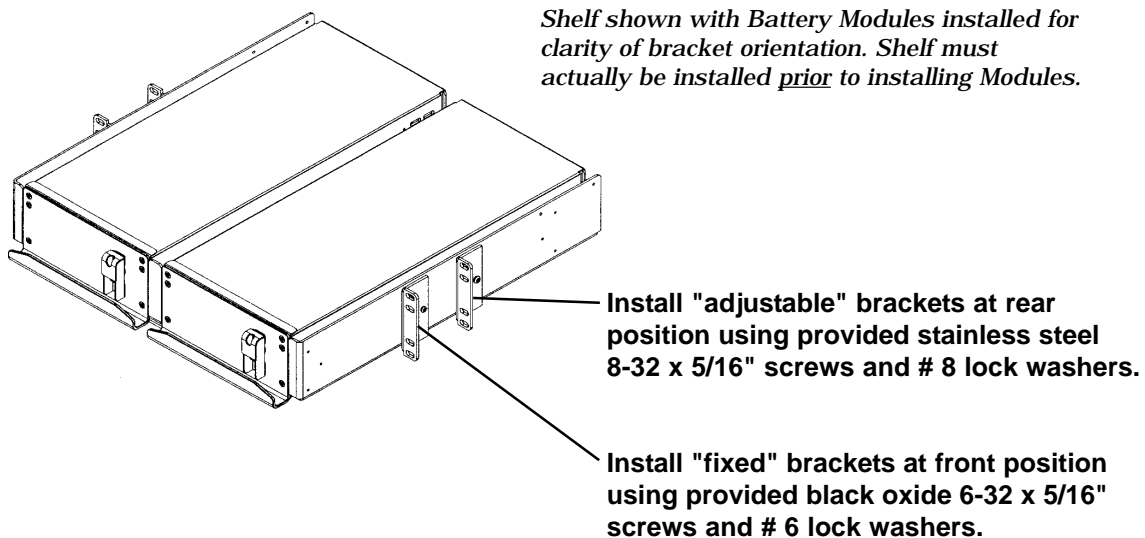

2) Cabinet Mounting Option: A cabinet mounting kit is also available from NEWMAR. The kit consists of three sets of adjustable rear support brackets which, when used with one set of the fixed brackets provided with the BMS in a flush mount configuration, facilitates mounting in most standard communication equipment cabinets. The cabinet mounting configuration is illustrated below with front-to-rear dimension ranges specified:

FIGURE 2: Cabinet Mounting Option

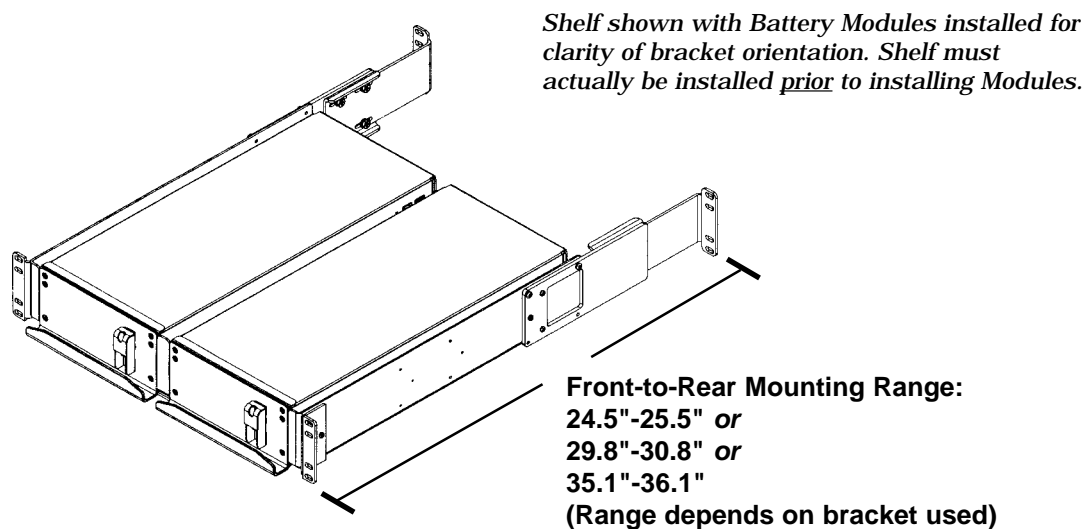

To order the cabinet mounting option contact the factory and request model RSB-19 for 19" racks or model RSB-23 for 23" racks.

II) BM (BATTERY MODULE) INSTALLATION

A) Materials

Check to see that each of the following items have been included with the BM packaging. For any missing items please contact the factory.

- (1 ea.) BM Series Battery Module
- (1 ea.) Model CC-24; Keyed Connector-to-Connector Two Conductor Wiring Assembly, 24 "
- (1 ea.) Customer Satisfaction/Warranty Card

B) Mounting

The BM Series Battery Module has been designed for two different mounting options; **1)** Installation in conjunction with NEWMAR's BMS Battery Module Shelf or **2)** "Universal" table-top, wall or under-shelf mount.

1) Battery Module Shelf Installation

The Battery Module Shelf will hold one or two 48, 24 or 12 volt NEWMAR Battery Modules. No extra hardware is required for mounting in the BMS. *Caution: Always ensure that the circuit breaker on the front panel is in the "OFF" position prior to installing or removing the Battery Module.*

To install the Module, simply slide it firmly into one of the two shelf bays until it is "captured" by the snap-lock mechanism at the rear of the shelf. Slide the second module (if used) into the remaining bay and turn the latch in the front center of the shelf to the horizontal position so that the modules are secured in place. The keyed terminals will then be accessible for easy connection at the rear of the shelf, and the modules will be prevented from sliding out when the connectors are pressed into the rear terminals.

To remove the Module, simply turn the front latch to the vertical position, grasp the horizontal grip on the front base of the Module and pull firmly outward until it is released by the snap-lock mechanism. (It is a pressure mechanism only; there is no latch or clasp at the rear to release.)

2) "Universal" Mounting Option (Table-top, Wall or Under-shelf) : Two 14" long universal brackets are available from the factory which may be attached to the sides of an individual Battery Module to secure it above or below a horizontal surface, or to a vertical surface, as required (see FIGURES 3A, 3B, 3C below). To order, contact the factory and request model UMB-PM.

Each Battery Module requires a separate set of universal brackets. Tapped bracket attachment holes in the side of the chassis allow for installation of the bracket flanges oriented toward either the top or bottom of the unit. The internal batteries are a sealed type and are tightly secured within the unit, so mounting with any orientation using these brackets is acceptable.

Attach the brackets using the twelve 6-32 x 3/8" pan-head phillips machine screws provided. Install three rubber grommets (provided) in each mounting bracket. WD-40 or a similar lubricant will ease installation of the grommets.

Secure the Battery Module to the mounting surface with six 1/4" screws or lag bolts (not provided).

FIGURES 3A, 3B, 3C: Universal Mounting Options

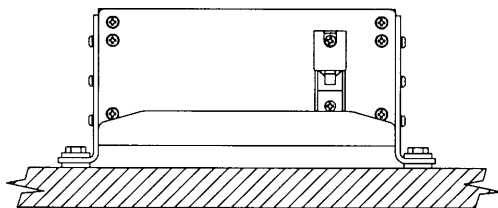

3A: Table-top Mount
The input output terminals of the BM are 100 % isolated from the case, therefore mounting to either metal or non-metal surfaces is acceptable.

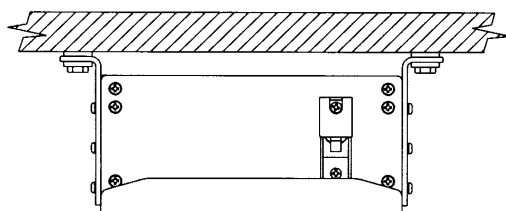

C) Input/Output Wiring 3B: Under-Shelf Mount

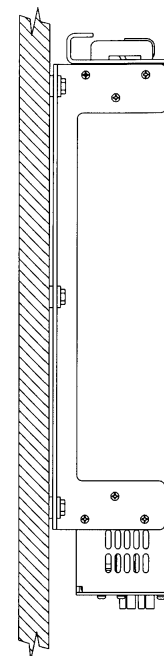

3C: Wall Mount

- 1) A 24", two conductor, 8 AWG wire assembly terminated at each end with keyed modular power connectors (labeled CC-24 in the installation kit) is provided for easy connection of the Battery Module to the rectifier (provided it uses a compatible input/output connector) or for parallel connections to additional Battery Modules.
- 2) The BM Series Battery Modules have been engineered as an ideally compatible reserve power source for NEWMAR's IPS Integrated Power Systems. Accordingly, the IPS features an external battery terminal/connector which mates with the connector-to-connector assembly provided with the Battery Module.
- 3) If the rectifier to be connected uses output studs (or an incompatible connector) one end of the provided connector assembly must be cut off and the wires terminated with ring lug connectors (or a compatible connector) to suit the installation. A 24" long connector assembly may also be obtained from NEWMAR which has a BM compatible connector on one end and a pair of ring terminals on the other, suitable for 1/4" rectifier output studs. Contact the factory and request model CA-24.
- 4) Note that although the positive and negative terminals of the BM input/output connectors are identified "+" and "-", and the connectors are keyed to prevent reverse polarity, the two input/output connectors themselves are undifferentiated. That is because these are parallel connections, and it makes no difference which is used for connection to the rectifier or parallel Battery Module. Dual connectors are provided simply for ease of installation, especially when "daisy-chaining" two or more Battery Modules.

FIGURE 4 below illustrates a typical wiring scheme with four Battery Modules mounted in two Battery Shelves in a "daisy-chain" configuration to provide extended battery back-up for a NEWMAR IPS.

FIGURE 4: Typical Battery Module Wiring

Note: For ease of illustration, a single line is used here to represent the dual "+" and "-" wires of the CC-24 and CA-24 connector assemblies.

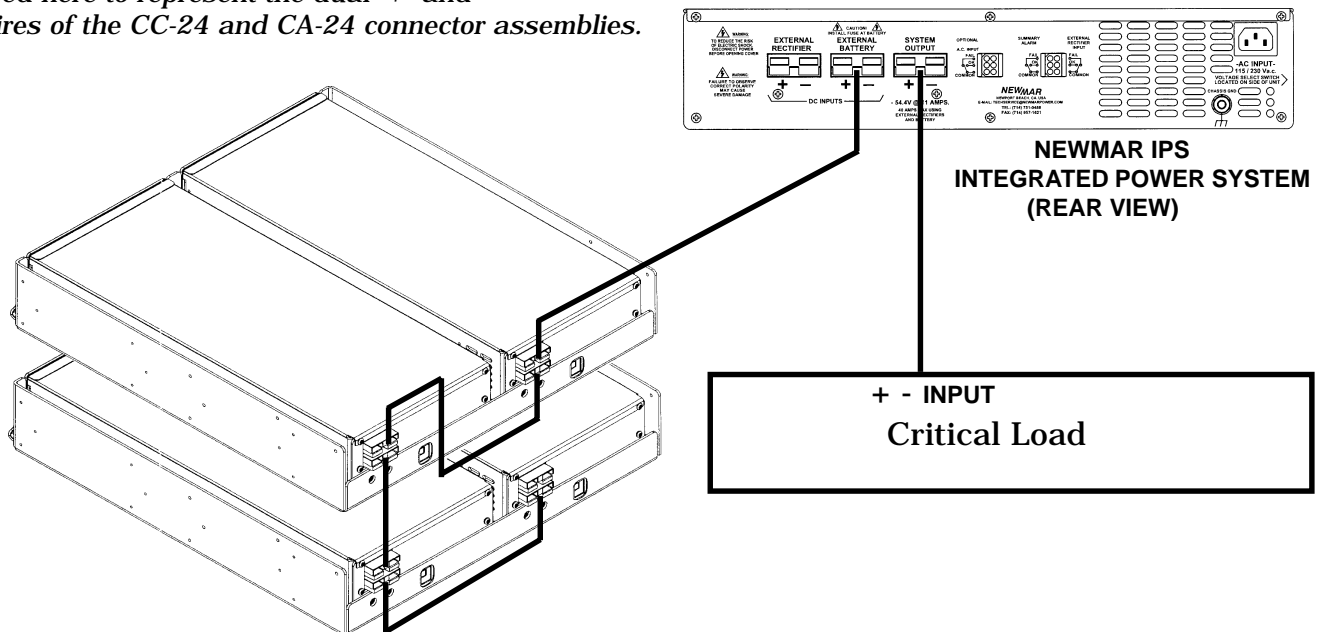

5) After installation and wiring are completed, be sure to place the circuit breaker in the front panel to the "ON" position to enable battery charging and to provide uninterrupted DC output to the load in case of rectifier failure. The over-current protection provided by the front panel circuit breaker depends on model as follows:

<u>Model</u>	<u>Breaker Value</u>
BM-48-4	20 amps
BM-24-8	40 amps
BM-12-16	50 amps

III) INTERNAL BATTERIES

A) General Performance Information

The built-in battery bank of the BM consists of four sealed lead-acid 12 volt, 4.0 amp-hour batteries which are wired in series, series-parallel or parallel, to provide 48, 24 or 12 VDC nominal voltage, depending on model.

The wiring configuration and internal reserve capacity of each model is as follows:

<u>Model</u>	<u>Wiring Configuration</u>	<u>Reserve Capacity</u>
BM-48-4	Series	4 Amp-Hours
BM-24-8	Series-Parallel	8 Amp-Hours
BM-12-16	Parallel	16 amp-hours

The chart on the following page may be used to determine the maximum constant current draw on battery back-up based upon **1)** desired run time, **2)** Battery Module model, and **3)** the number of Battery Modules wired into the system:

Constant Current Performance (Amps) to 1.75 VPC @ 25° C

(Note: N/R = Not Recommended)

Model	Run Time	Number of Battery Modules					
		One	Two	Three	Four	Five	Six
BM-48-4	5 Minutes	11.6	23.2	34.8	40 max.	N/R	N/R
	15 Minutes	6.4	12.8	19.2	25.6	32.0	38.4
	30 Minutes	4.0	8.0	12.0	16.0	20.0	24.0
	1 Hour	2.2	4.4	6.6	8.8	11.0	13.2
	2 Hours	1.4	2.8	11.0	4.2	5.6	7.0
	4 Hours	.8	1.6	2.4	3.2	4.0	4.8
	8 Hours	.17	.34	.50	.67	.84	1.0
	24 Hours	.5	1.0	1.4	1.9	2.4	2.9
	BM-24-8	5 Minutes	23.2	40 max.	N/R	N/R	N/R
15 Minutes		12.8	25.6	38.4	40 max.	N/R	N/R
30 Minutes		8.0	16.0	24.0	32.0	40.0 max.	N/R
1 Hour		4.4	8.8	13.2	17.6	22.0	26.4
2 Hours		2.8	5.6	8.4	11.2	14.0	16.8
4 Hours		1.6	3.2	4.8	6.4	8.0	9.6
8 Hours		1.0	1.9	2.9	3.8	4.8	5.8
24 Hours		.34	.67	1.0	1.3	1.7	2.0
BM-12-16		5 Minutes	40 max.	N/R	N/R	N/R	N/R
	15 Minutes	25.2	40 max.	N/R	N/R	N/R	N/R
	30 Minutes	16.0	32.0	40 max.	N/R	N/R	N/R
	1 Hour	9.6	19.2	28.8	38.4	40 max.	N/R
	2 Hours	5.6	11.2	16.8	22.4	28.0	33.6
	4 Hours	3.0	6.0	9.0	12.0	15.0	18.0
	8 Hours	1.9	3.8	5.8	7.7	9.6	11.5
	24 Hours	.67	1.3	2.0	2.7	3.4	4.0

If the installation requires longer run time or higher current draw than shown in this chart, please contact the factory for additional options.

B) Load Testing the Batteries

All batteries are subject to a certain loss of capacity over time. The rate of capacity loss will depend on a number of factors such as age, ambient temperature and number of charge/discharge cycles. Therefore, in order to guarantee that the batteries will provide the required back-up in an emergency loss of AC power, it is recommended that they be periodically load tested to verify sufficient back-up capacity. This test will also serve the valuable function of “exercising “ the batteries, which contributes to longer life.

The first load test should be performed as soon as possible after installation. The results should be recorded in section V as a benchmark for comparison to all future test results. The batteries must begin fully charged for the test to be accurate. If unsure about the relative state of the batteries, allow the rectifier to run for 24 hours with no load and the circuit breaker on the front panel of the Battery Module in the "ON" position. For the most accurate results, each battery module should be tested separately.

Note: This test procedure assumes an installation with a standard rectifier without built-in voltmeter and with the load and battery module connected to the output of the rectifier. Adjust the procedure as necessary to suit the system configuration. If the Battery Module is used in conjunction with a



Telecom Power Products

www.newmartelecom.com

U.S.A. HEADQUARTERS

P.O. Box 1306, Newport Beach, CA 92663

Phone: 714-751-0488 Fax: 714-957-1621

E-Mail: sales@newmarpower.com

EURO WAREHOUSE

Phone:+31-35-603-2494

Fax:+31-35-603-2149

NEWMAR IPS Integrated Power System, use the test procedure in the accompanying Installation/ Operation manual for that product.

A reliably consistent load is required for this test. The maximum current of the test load must not exceed the 15 minute constant current performance rating of the Battery Capacity Chart in the previous section. Proceed with the test as follows:

- 1)** Connect the constant current load to the output terminals of the rectifier but leave the load turned off, initially. Ensure that the Battery Module to be tested is properly connected to the same (or parallel) output terminal, and that all other Battery modules are disconnected. Turn the rectifier on.
- 2)** Attach the "+" and "-" probes of a digital voltmeter to the "+" and "-" terminals of the unused connector on the rear of the Battery Module (which are in parallel to the terminals receiving charging voltage from the rectifier).
- 3)** Check the reading of the voltmeter to ensure that the rectifier is (has been) outputting proper charging voltage to the Battery Module, then shut the rectifier off.
- 4a)** If this is the first load test of the batteries, turn on the load and then record the reading of the digital voltmeter after precisely 5 minutes, 10 minutes and 15 minutes. These are the benchmark voltages you should use for future tests.
- 4b)** If this is a subsequent test, turn on the load and *record the amount of time it takes for the batteries to reach the benchmark voltages recorded in step 4a.* When the batteries are under the identical constant current load as in the initial test and nonetheless fall to the benchmark voltages 20 % faster (i.e., at 4, 8 or 12 minutes) they should be replaced. If replacement is indicated, see the following section for procedure.

C) Internal Battery Replacement

Typical life of the internal batteries is 3-5 years in standby use. Actual life will depend on various factors, such as ambient temperature, number of charge/discharge cycles, etc. *Regardless of use, batteries should be changed within a maximum of 5 years to ensure reliable performance in an emergency power loss.*

Replacement batteries are available from NEWMAR. Contact the factory and specify part number 591-0412-0, 12 volt 4.0 A-H battery. If you use batteries obtained from another source, ensure that they are of the same type, rating and approximate age. All batteries should be replaced at the same time.

To determine the age of the batteries in the Battery Module, refer to the label on the front of the unit. The first four digits of the serial number (designated "S/N") refer to the year and month of manufacture. For instance, a unit with a serial number starting "0135" was manufactured the 35th week of 2001. Be sure to mark the date of replacement in a conspicuous place on or near this label for future reference.

Caution: Take care not to short the battery terminals during removal and installation. The resulting high current will damage the batteries.

A blank section for logging technician's notes has been provided at the end of this manual,

section V. It is recommended that a record be made there of this service performed upon completion. Proceed with battery replacement as follows:

- 1) Ensure that the circuit breaker on the front panel is in the "OFF" position. Disconnect all connector assemblies from the terminals on the rear panel.
- 2) Turn the front panel latch to the vertical position. Grasp the horizontal grip on the front base of the Module and pull firmly outward until it is released by the snap-lock mechanism. Slide the Module out of the shelf. (Note: If Battery Module is mounted using "universal" brackets in either a vertical (wall-mount) or undershelf configuration, it must be removed and set on a flat horizontal surface. If it is desktop mounted, it need not be removed.)
- 3) Loosen but do not remove the two black # 6 phillips head screws on the top rear of the unit which secure the cover. Remove the cover.
- 4) Note that there are two hold-down brackets, each securing two batteries. Using a 3/8" nut driver, remove the four nuts which secure the two brackets to the base of the unit.
- 5) Carefully note the orientation of the internal batteries and hook-up configuration of the wiring. *It is critical that the wiring is properly reconnected when replacing the batteries or extreme damage will result.* Refer to the Battery Wiring Diagrams on the following page. Note that the permanently affixed internal wires in the Battery Module will match the color code (red or black) on the battery terminals, however the color of the jumper wires may not.
- 6) Remove each battery and dispose of properly and according to local codes. Although the batteries are sealed, they are of lead-acid construction and there may be restrictions on their disposal.
- 7) Set the new batteries in place within the unit and re-attach the wires to the proper terminals as shown in FIGURE 5A, 5B, or 5C below.

FIGURE 5A: BM-48-4 Battery Wiring (Note circuit breaker is in negative leg)

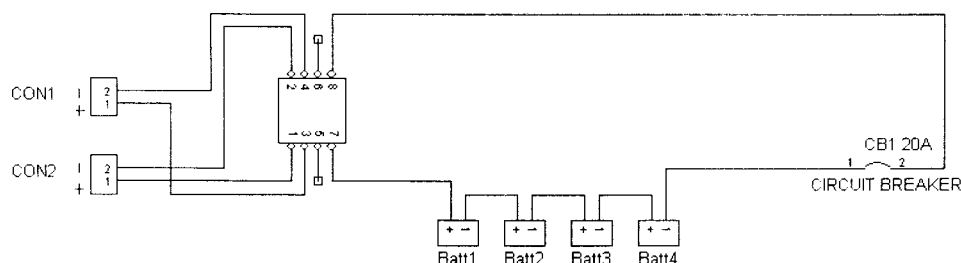

FIGURE 5B: BM-24-8 Battery Wiring (Note circuit breaker is in positive leg)

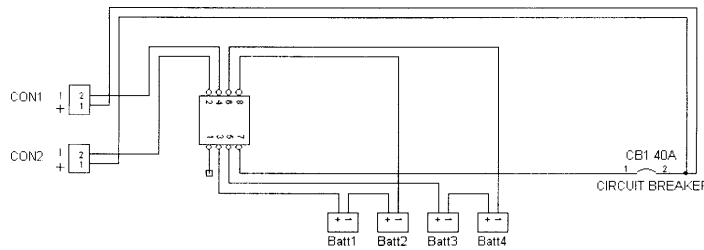
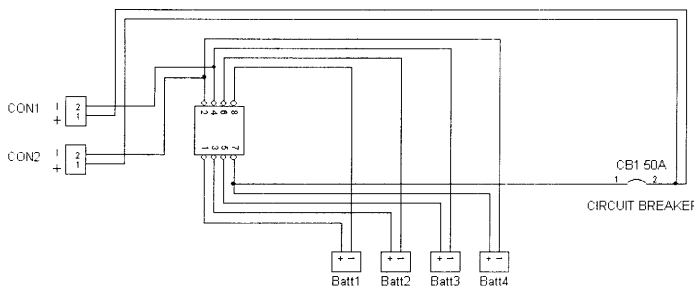

FIGURE 5C: BM-12-16 Battery Wiring (Note circuit breaker is in Positive leg)



8) Re-install the hold-down brackets and replace the cover. Reinstall the Battery Module into the Battery Module Shelf (or return it to its previous "universal" mounting configuration).

9) Reconnect the wiring/connector assemblies. Return the circuit breaker on the front panel to the "ON" position.

Note: If batteries are removed from the unit for storage, make sure they have been fully charged first. Storing batteries in a discharged condition will greatly shorten their life.

IV) SPECIFICATIONS

Model	Nominal Voltage VDC	Rec'd Float Voltage	Battery or Module Capacity	Circuit Breaker Protection	Dimensions Weight (Lbs.) H x W x D
BM-48-4	48	54.4	4 Amp-Hour	20 amp	19.8 3.4 X 7.4 X 18.8
BM-24-8	24	27.2	8 Amp-Hour	40 amp	19.8 3.4 X 7.4 X 18.8
BM-12-16	12	13.6	16 Amp-Hour	50 amp	19.8 3.4 X 7.4 X 18.8
BMS-19/23	n/a	n/a	1 or 2 BM's	n/a	4.9 3.5 X 19/23 X 18.2

BM Over-Current Protection: Circuit Breaker/Switch (see matrix for values). *Note: Breaker is in the Negative leg of model BM-48-4 and in the Positive leg of models BM-24-8 and BM-12-16.*

Battery Type: Lead-Acid; Sealed, maintenance-free. IATA and DOT certified for shipment by air.

Battery Weight (Individually): 3.75 Lbs.

Typical Battery Life: 3-5 years in standby use

Options

- * "Universal" mounting brackets (for individual modules): Model UMB-PM
- * Rear support brackets for cabinet/flush mounting: Model RSB-19 or RSB-23
- * Additional Cable/Connectors: Model CC-24, Connector-to-connector wire assembly, 24'
Model CA-24, Connector-to-ring lug wire assembly, 24'
Model CK-50, Connector only, 50 amp, self-assembly



